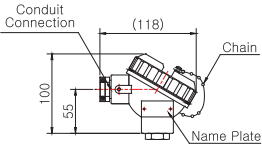
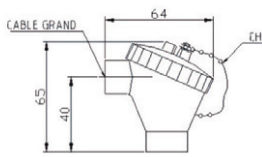
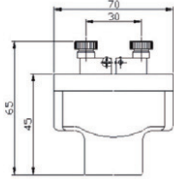
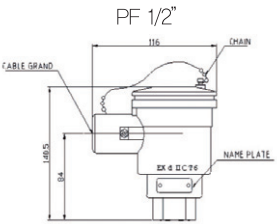
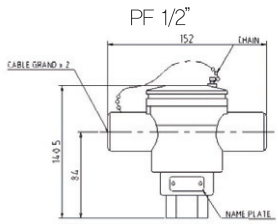
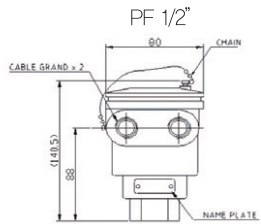
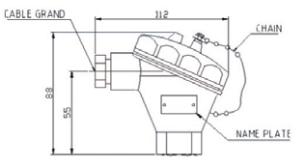
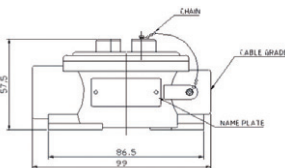
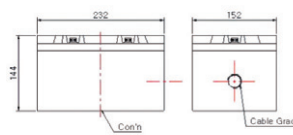

Thermocouple

Model No. SS-5010 Series

Terminal Boxes

Type	Weather Proof W	General Purpose S	Exposed Terminal L
<p>Material : Conduit Conn : No. of Terminals : Terminal Block : Surface Finish : Surface Color :</p>	<p>Al-alloy diecast, Cast Iron PF1/2 . PF3/4 2, 3, 4, 6 Bakelite . Ceramic Melamin baked Metallic silver</p>	<p>Al-alloy diecast, Phenol Resin PF3/8 2, 3 Bakelite . Ceramic Melamin baked Metallic silver</p>	<p>Al-ally diecast - 2 Bakelite . Ceramic Melamin baked Metallic silver</p>
<p>Dimensions</p>	<p>PF 1/2 (W/Cable Gland), PF3/4</p> 	<p>PF 1/4</p> 	<p>PF1/2</p> 
Type	Flame Proof E (EX d II C T6)	Two Way Entry	Two Entry
<p>Material : Conduit Conn : No. of Terminals : Terminal Block : Surface Finish : Surface Color :</p>	<p>Al-alloy diecast, Cast Iron Stainless steel PF1/2 . PF3/4 2, 3, 4, 6 Bakelite . Ceramic Melamin baked Metallic silver</p>	<p>Al-alloy diecast, Phenol Resin Stainless steel PF1/2x2 4, 6 Bakelite . Ceramic Melamin baked Metallic silver</p>	<p>Al-alloy diecast, Phenol Resin Stainless steel PF1/2x2 4, 6 Bakelite . Ceramic Melamin baked Metallic silver</p>
<p>Dimensions</p>	<p>PF 1/2"</p> 	<p>PF 1/2"</p> 	<p>PF 1/2"</p> 
Type	Weather Proof SW	D uctType	Multy Type (EX d II B T5)
<p>Material : Conduit Conn : No. of Terminals : Terminal Block : Surface Finish : Surface Color :</p>	<p>Al-alloy diecast, 316SS PF1/2 . PF3/4 2, 3, 4, 6 Bakelite . Ceramic Grinding Metallic silver</p>	<p>Al-alloy diecast, 316SS PF1/2 . PF3/4 2, 3, 4, 6 Bakelite . Ceramic Melamin baked Metallic silver</p>	<p>Al-alloy diecast PF3/4 10, 20 Bakelite . Ceramic Pulverulent-Coating Hammer-Tone</p>
<p>Dimensions</p>	<p>PF 1/2"</p> 	<p>PF 1/2"</p> 	<p>PF 1/2"</p> 

Weather Proof Head Type

Model No. | SS-5011W
(Metal Protection Tube)

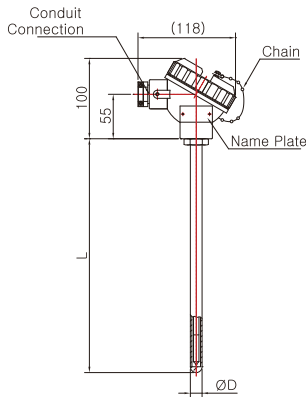

Model No. | SS-5011W-1
(Ceramic Protection Tube)

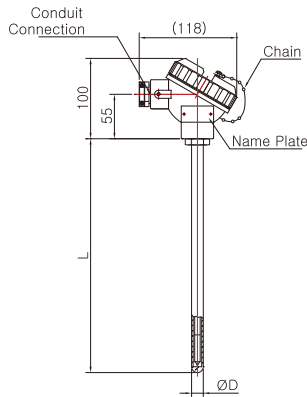

Model No. | SS-5011W-2
(Ceramic Protection Tube)

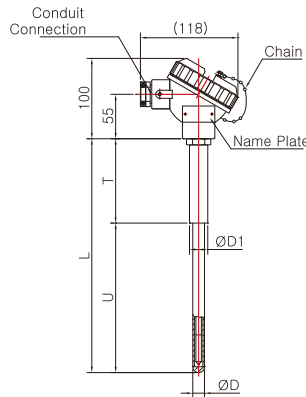

Model No. | SS-5011W-3
(Dual Ceramic Protection Tube)

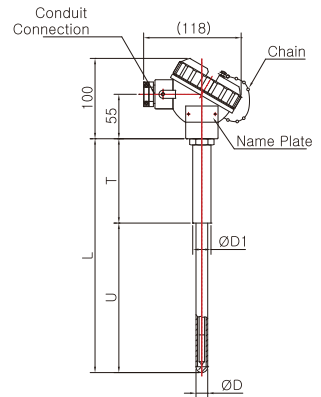

Model No. | SS-5011W-4
(Metal Protection Tube)

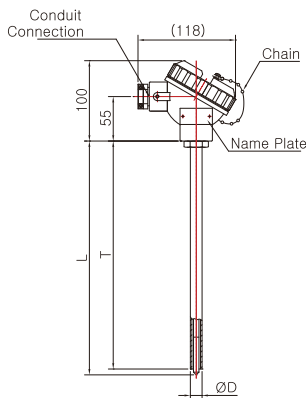

Model No. | SS-5012W
(Metal Protection Tube)

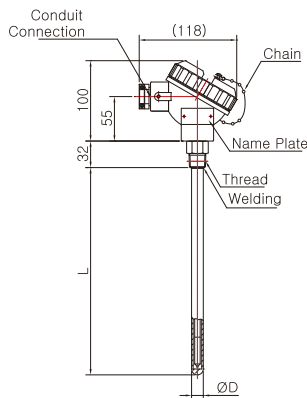

Model No. | SS-5012W-1
(Metal Protection Tube)

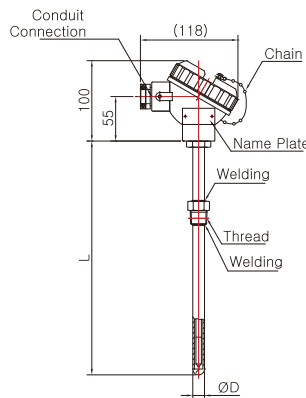

Model No. | SS-5012W-2
(Metal Protection Tube)

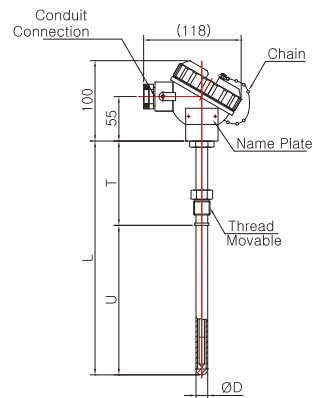

Model No. | SS-5012W-3
(Metal Protection Tube)

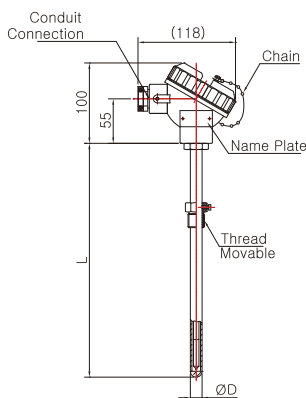

Model No. | SS-5012W-4
(Metal Protection Tube)

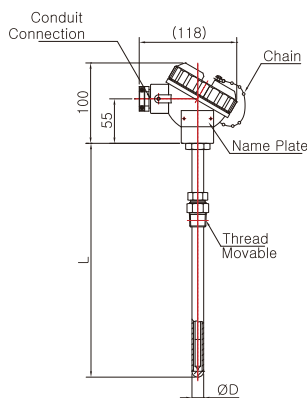

Model No. | SS-5013W
(Metal Protection Tube)

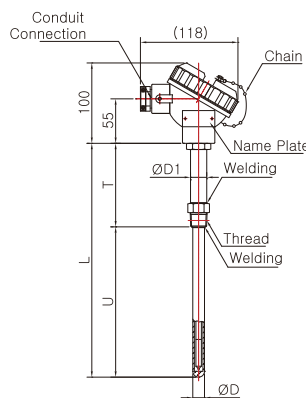

Model No. | SS-5013W
(Ceramic Protection Tube)

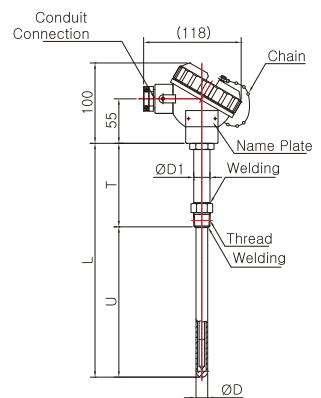

Pressure Gauge

Differential Pressure Gauge & Switch

Accessories of Pressure Gauge

Thermometer & Thermometer Switch

Thermocouple & R.T.D

Thermowell

Transmitter

Indicator etc.

Technical data

Thermocouple

Model No. SS-5010 Series

Weather Proof Head Type

Model No. | SS-5014W
(Ceramic Protection Tube)

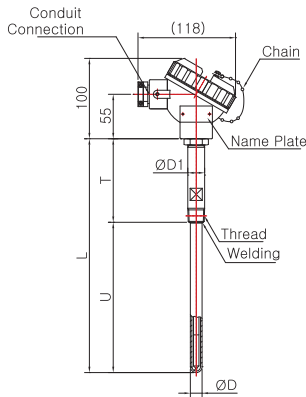

Model No. | SS-5014W-1
(Metal Protection Tube)

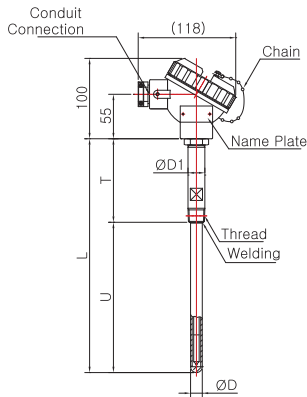

Model No. | SS-5014W-1-1
(Metal Protection Tube)

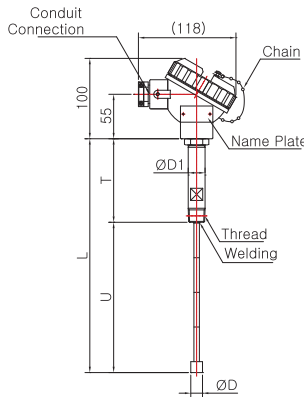

Model No. | SS-5014W-2
(Metal Protection Tube)

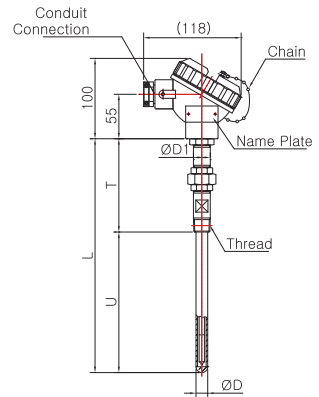

Model No. | SS-5014W-2-1
(Metal Protection Tube)

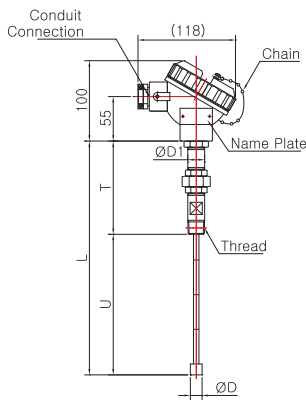

Model No. | SS-5014W-3
(Metal Protection Tube)

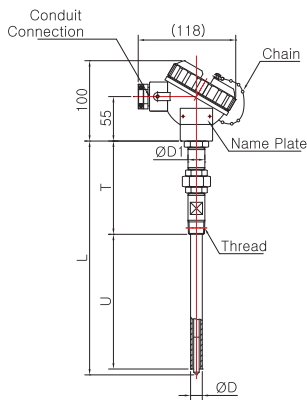

Model No. | SS-5015W
(Metal Protection Tube)

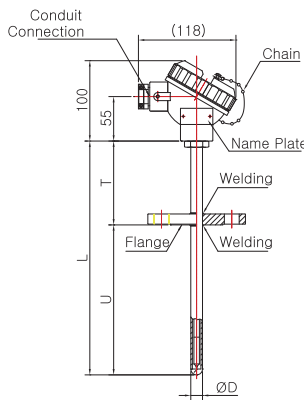

Model No. | SS-5015W-1
(Metal Protection Tube)

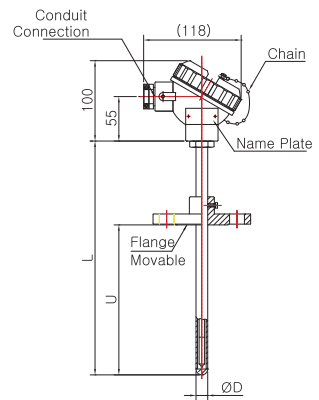

Model No. | SS-5016W
(Metal Protection Tube)

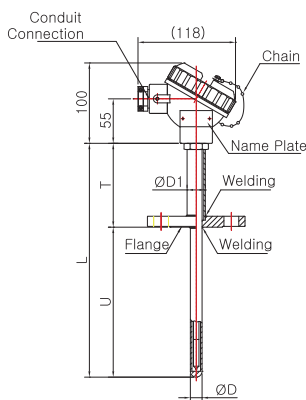

Model No. | SS-5016W-1
(Ceramic Protection Tube)

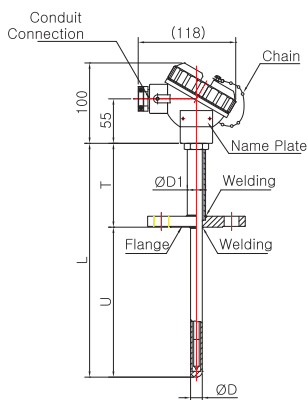

Model No. | SS-5016W-2
(Metal Protection Tube)

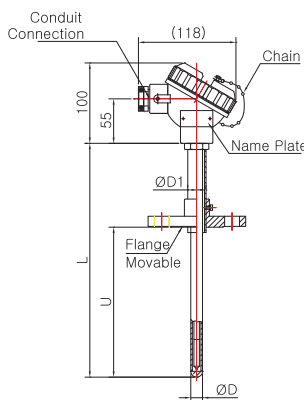

Model No. | SS-5016W-3
(Metal Protection Tube)

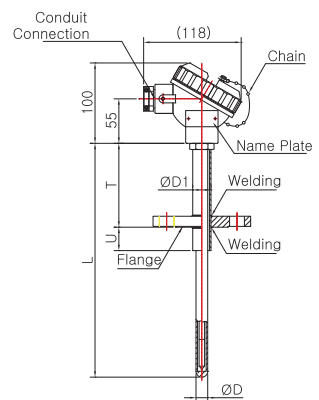

Pressure Gauge
Differential Pressure Gauge & Switch
Accessories of Pressure Gauge
Thermometer & Thermometer Switch
Thermocouple & R.T.D
Thermowell
Transmitter
Indicator etc.
Technical data

Weather Proof Head Type

Model No. | SS-5017W
(Metal Protection Tube)

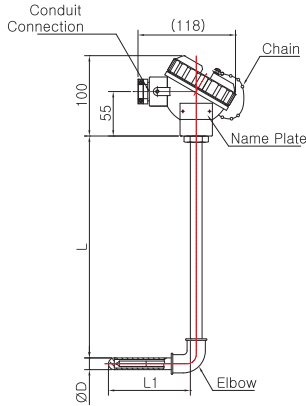

Model No. | SS-5019W
(Metal Protection Tube)

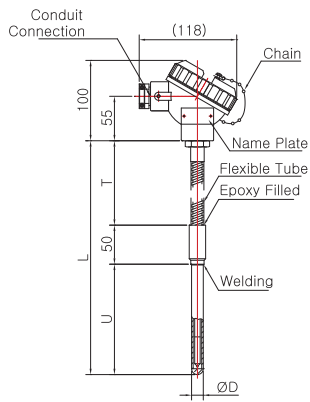

Model No. | SS-5019W-1
(Metal Protection Tube)

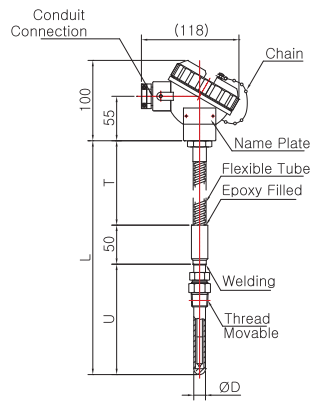

Model No. | SS-5019W-2
(Metal Protection Tube)

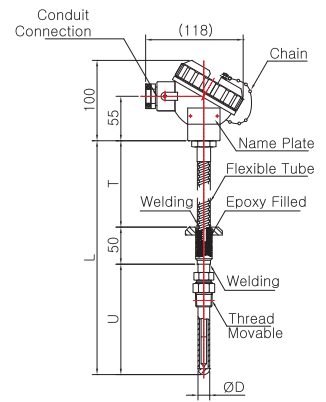

Pressure Gauge

Differential Pressure Gauge & Switch

Accessories of Pressure Gauge

Thermometer & Thermometer Switch

Thermocouple & R.T.D

Thermowell

Transmitter

Indicator etc.

Technical data

Thermocouple

Model No. SS-5010 Series

Explosion Proof Head Type (Ex d IIC T6)

Model No. | SS-5011E
(Metal Protection Tube)

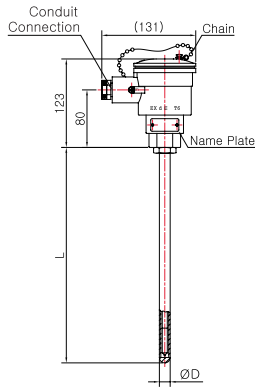

Model No. | SS-5011E-1
(Ceramic Protection Tube)

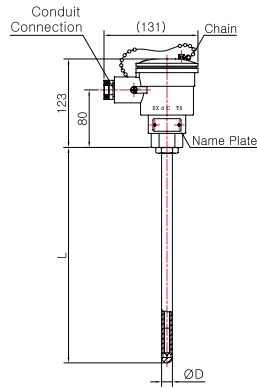

Model No. | SS-5011E-2
(Ceramic Protection Tube)

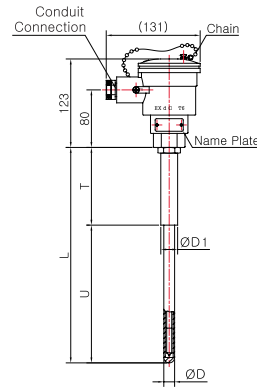

Model No. | SS-5011E-3
(Dual Ceramic Protection Tube)

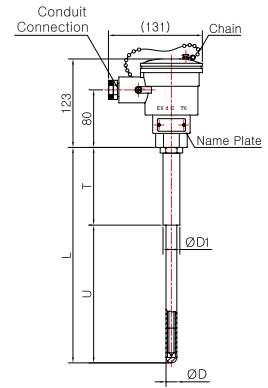

Model No. | SS-5011E-4
(Metal Protection Tube)

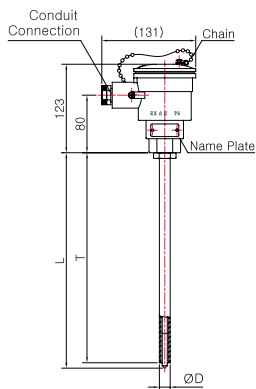

Model No. | SS-5012E
(Metal Protection Tube)

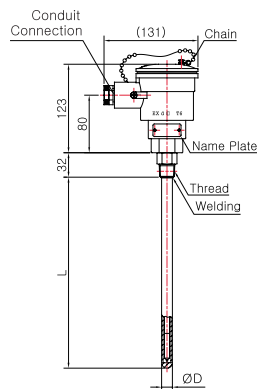

Model No. | SS-5012E-1
(Metal Protection Tube)

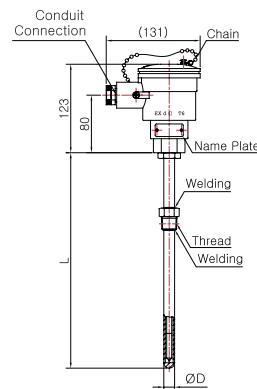

Model No. | SS-5012E-2
(Metal Protection Tube)

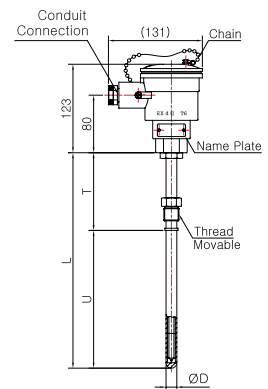

Model No. | SS-5012E-3
(Metal Protection Tube)

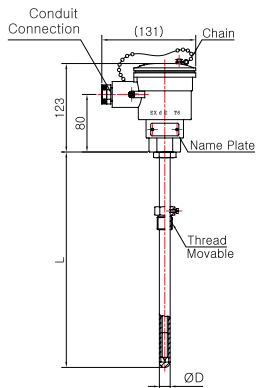

Model No. | SS-5012E-4
(Metal Protection Tube)

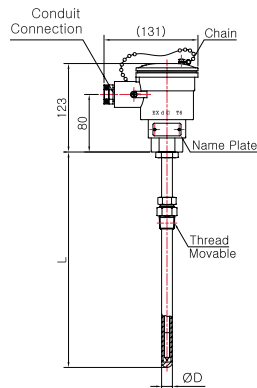

Model No. | SS-5013E
(Metal Protection Tube)

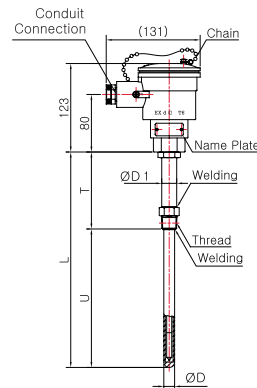

Model No. | SS-5013E-1
(Ceramic Protection Tube)

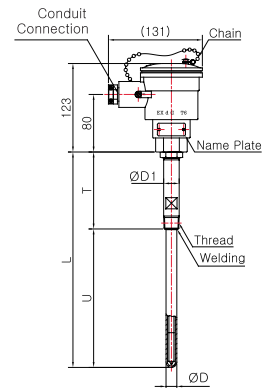

Pressure Gauge
Differential Pressure Gauge & Switch
Accessories of Pressure Gauge
Thermometer & Thermometer Switch
Thermocouple & R.T.D.
Thermowell
Transmitter
Indicator etc.
Technical data

Explosion Proof Head Type (Ex d IIC T6)

Model No. | SS-5014E
(Ceramic Protection Tube)

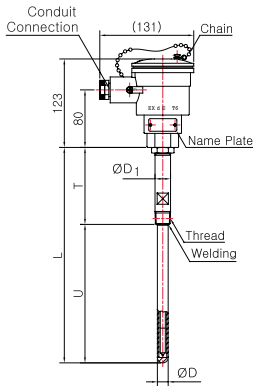

Model No. | SS-5014E-1
(Metal Protection Tube)

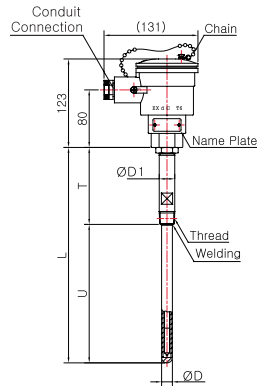

Model No. | SS-5014E-1-1
(Metal Protection Tube)

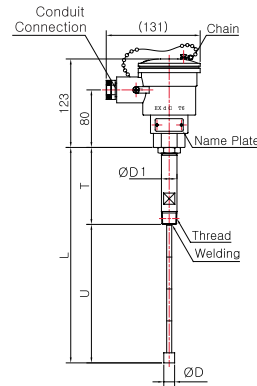

Model No. | SS-5014E-2
(Metal Protection Tube)

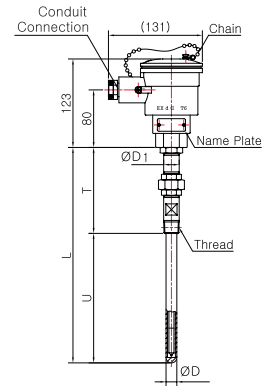

Model No. | SS-5014E-2-1
(Metal Protection Tube)

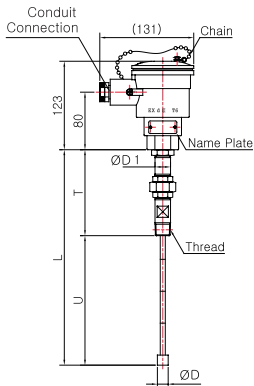

Model No. | SS-5014E-3
(Metal Protection Tube)

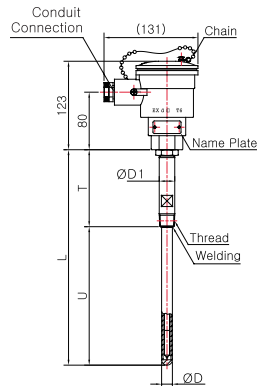

Model No. | SS-5015E
(Metal Protection Tube)

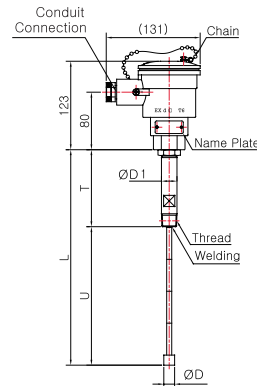

Model No. | SS-5013E-1
(Metal Protection Tube)

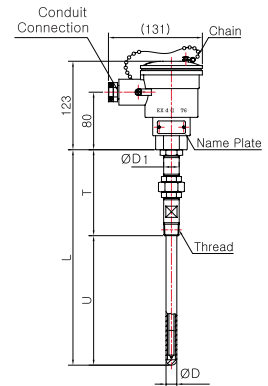

Model No. | SS-5016E
(Metal Protection Tube)

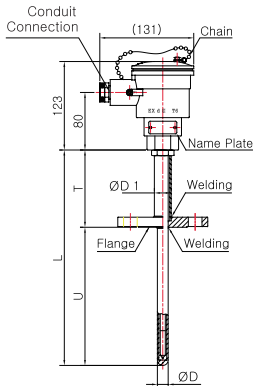

Model No. | SS-5016E-1
(Ceramic Protection Tube)

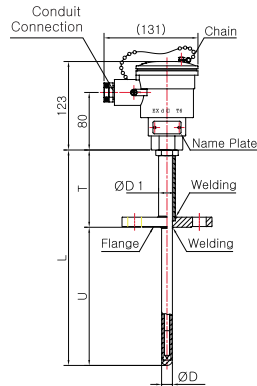

Model No. | SS-5016E-1
(Metal Protection Tube)

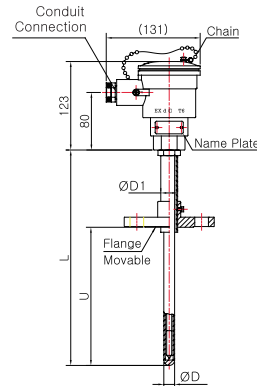

Model No. | SS-5016E-3
(Metal Protection Tube)

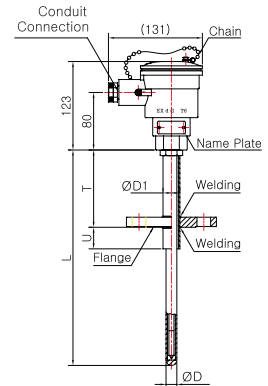

Pressure Gauge

Differential Pressure Gauge & Switch

Accessories of Pressure Gauge

Thermometer & Thermometer Switch

Thermocouple & R.T.D

Thermowell

Transmitter

Indicator etc.

Technical data

Thermocouple

Model No. SS-5010 Series

Explosion Proof Head Type (Ex d IIC T6)

Model No. | SS-5017E
(Metal Protection Tube)

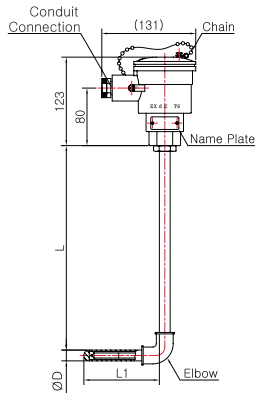

Model No. | SS-5019E
(Metal Protection Tube)

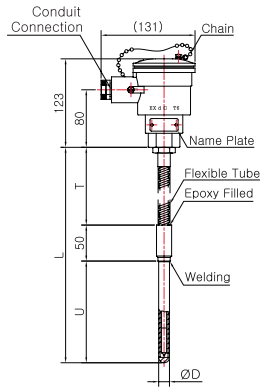

Model No. | SS-5019E-1
(Metal Protection Tube)

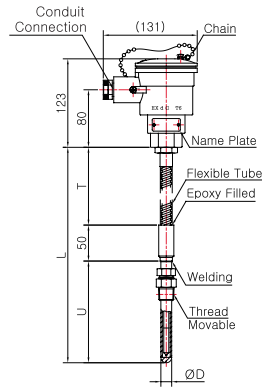

Model No. | SS-5019E-2
(Metal Protection Tube)

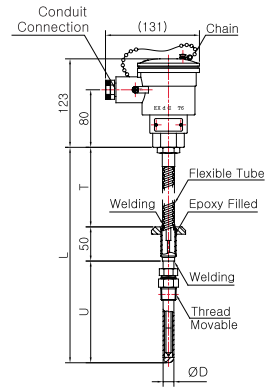

- Pressure Gauge
- Differential Pressure Gauge & Switch
- Accessories of Pressure Gauge
- Thermometer & Thermometer Switch
- Thermocouple & R.T.D.
- Thermowell
- Transmitter
- Indicator etc.
- Technical data

General Purpose Head Type

Model No. | SS-5011S
(Ceramic Protection Tube)

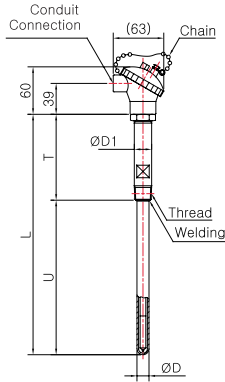

Model No. | SS-5011S-1
(Ceramic Protection Tube)

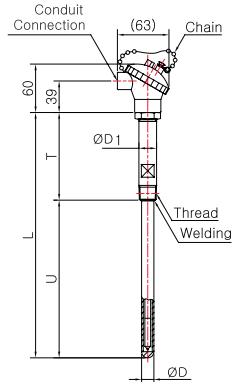

Model No. | SS-5011S-2
(Ceramic Protection Tube)

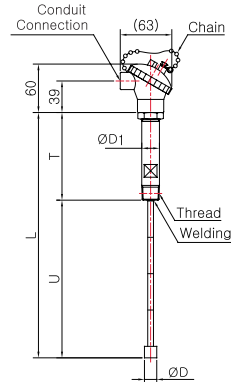

Model No. | SS-5011S-3
(Ceramic Protection Tube)

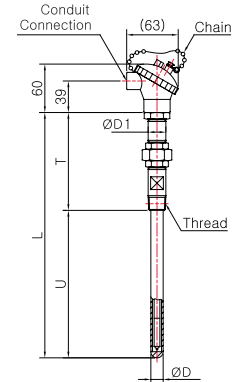

Model No. | SS-5011S-4
(Metal Protection Tube)

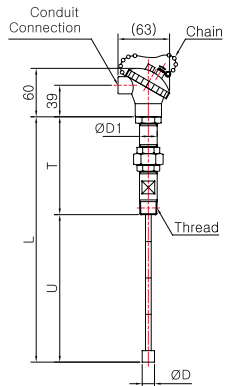

Model No. | SS-5012S
(Metal Protection Tube)

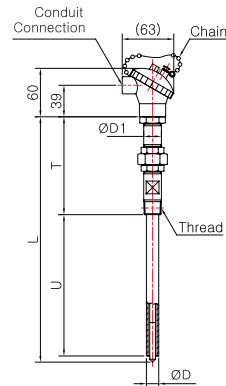

Model No. | SS-5012S-1
(Metal Protection Tube)

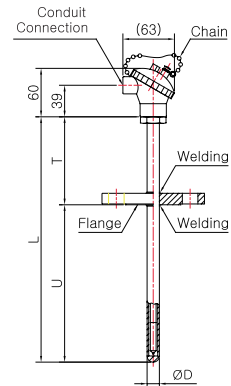

Model No. | SS-5012S-2
(Metal Protection Tube)

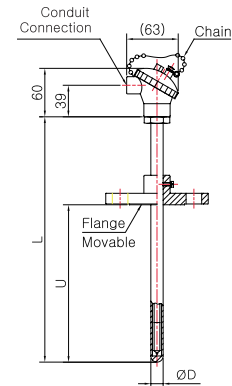

Model No. | SS-5012S-3
(Metal Protection Tube)

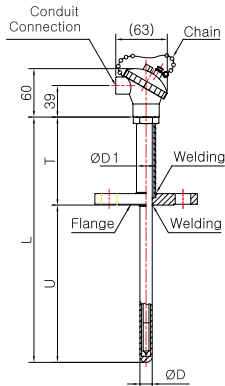

Model No. | SS-5012S-4
(Metal Protection Tube)

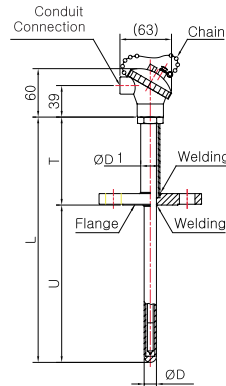

Model No. | SS-5013S
(Metal Protection Tube)

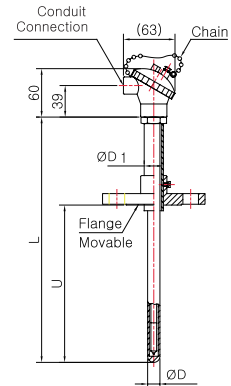

Model No. | SS-5013S-1
(Ceramic Protection Tube)

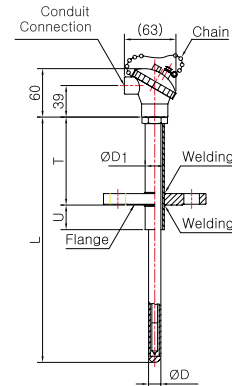

Pressure Gauge

Differential Pressure Gauge & Switch

Accessories of Pressure Gauge

Thermometer & Thermometer Switch

Thermocouple & R.T.D

Thermowell

Transmitter

Indicator etc.

Technical data

Thermocouple

Model No. SS-5010 Series

General Purpose Head Type

Model No. | SS-5014S
(Ceramic Protection Tube)

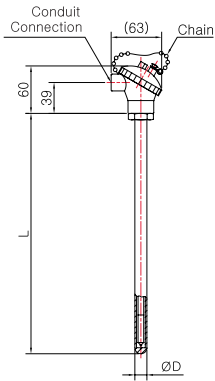

Model No. | SS-5014S-1
(Metal Protection Tube)

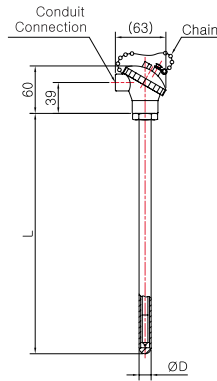

Model No. | SS-5014S-1-1
(Metal Protection Tube)

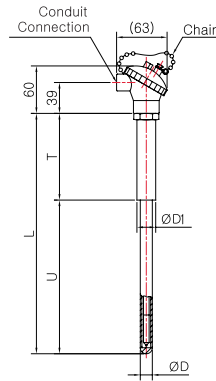

Model No. | SS-5014S-2
(Metal Protection Tube)

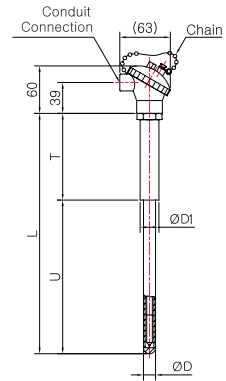

Model No. | SS-5014S-2-1
(Metal Protection Tube)

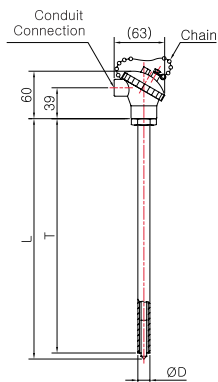

Model No. | SS-5014S-3
(Metal Protection Tube)

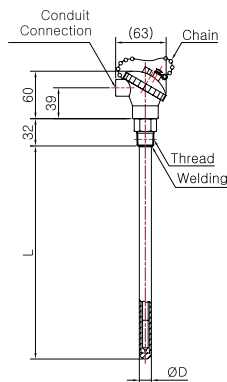

Model No. | SS-5015S
(Metal Protection Tube)

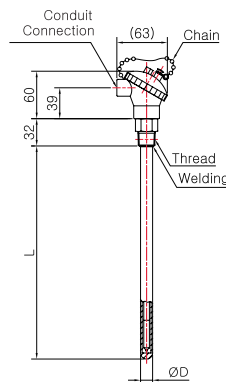

Model No. | SS-5015S-1
(Metal Protection Tube)

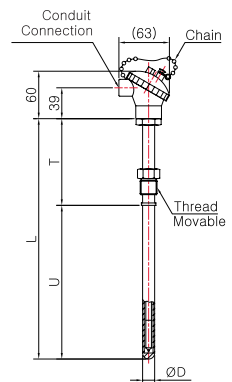

Model No. | SS-5016S
(Metal Protection Tube)

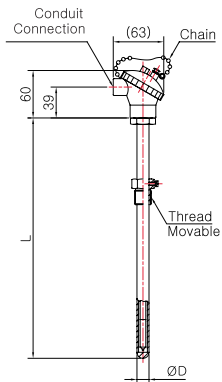

Model No. | SS-5016S-1
(Ceramic Protection Tube)

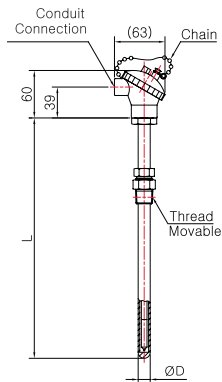

Model No. | SS-5016S-2
(Metal Protection Tube)

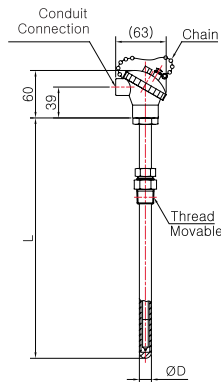

Model No. | SS-5016S-3
(Metal Protection Tube)

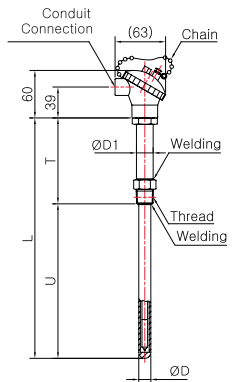

Pressure Gauge
Differential Pressure Gauge & Switch
Accessories of Pressure Gauge
Thermometer & Thermometer Switch
Thermocouple & R.T.D.
Thermowell
Transmitter
Indicator etc.
Technical data

General Purpose Head Type

Model No. | SS-5017S
(Metal Protection Tube)

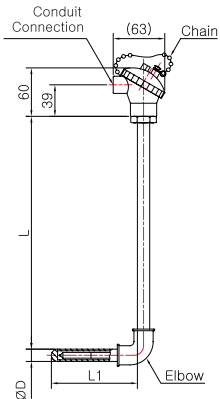

Model No. | SS-5019S
(Metal Protection Tube)

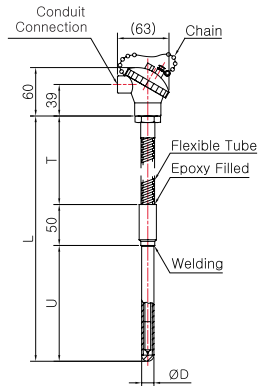

Model No. | SS-5019S-1
(Metal Protection Tube)

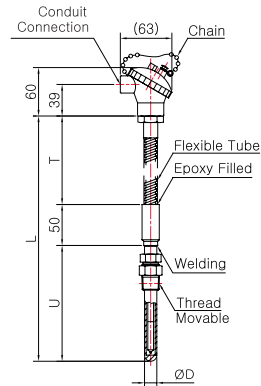

Model No. | SS-5019S-2
(Metal Protection Tube)

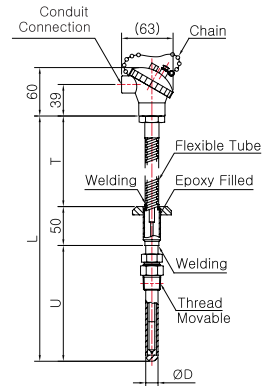

Pressure Gauge

Differential Pressure Gauge & Switch

Accessories of Pressure Gauge

Thermometer & Thermometer Switch

Thermocouple & R.T.D

Thermowell

Transmitter

Indicator etc.

Technical data

Sheath Thermocouple

Model No. SS-5020 Series

Weather Proof Head Type

Model No. | SS-5021W
(Sheath)

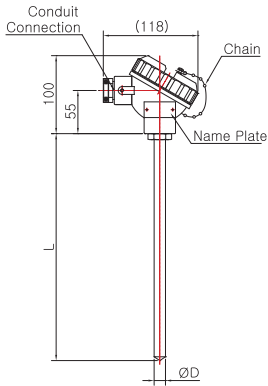

Model No. | SS-5022W
(Sheath)

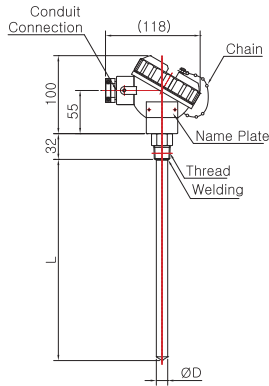

Model No. | SS-5022W-1
(Sheath)

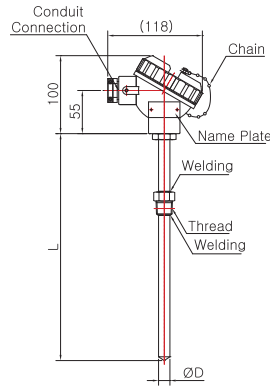

Model No. | SS-5022W-2
(Sheath)

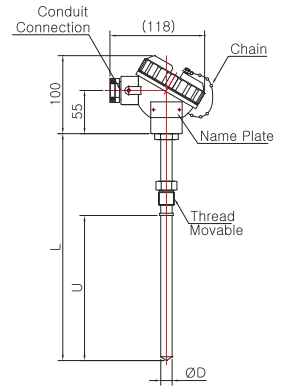

Model No. | SS-5022W-3
(Sheath)

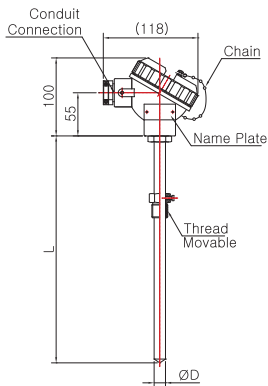

Model No. | SS-5022W-4
(Sheath)

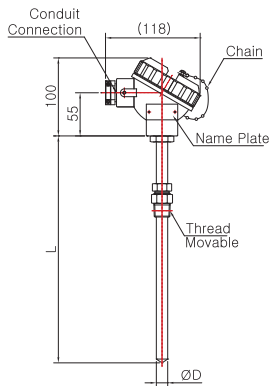

Model No. | SS-5023W
(Sheath)

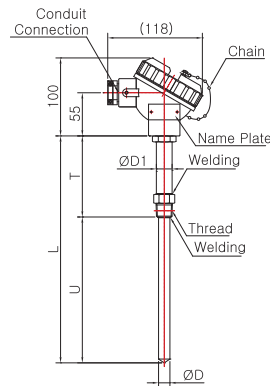

Model No. | SS-5023W-1
(Sheath)

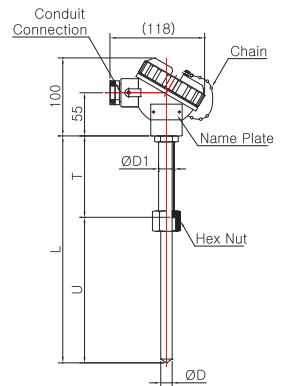

Model No. | SS-5024W-1
(Sheath)

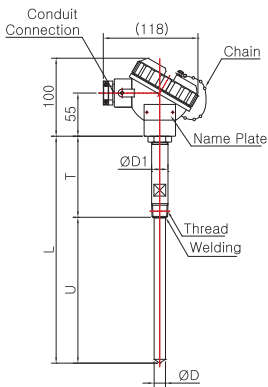

Model No. | SS-5024W-1-1
(Sheath Spring Load)

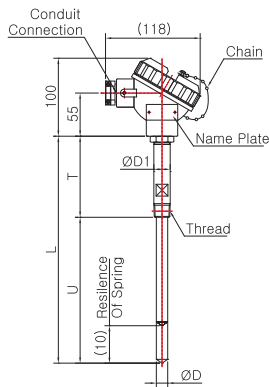

Model No. | SS-5024W-2
(Sheath)

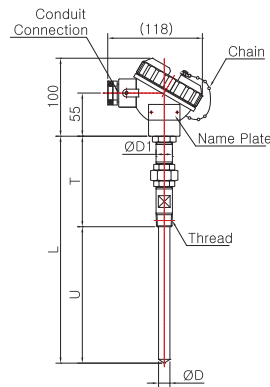

Model No. | SS-5024W-2-1
(Sheath Spring Load)

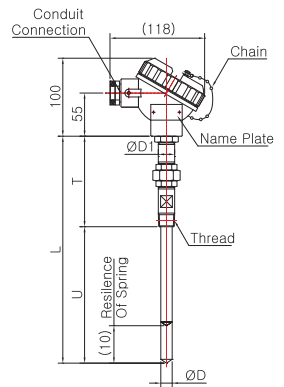

Pressure Gauge
Differential Pressure Gauge & Switch
Accessories of Pressure Gauge
Thermometer & Thermometer Switch
Thermocouple & R.T.D
Thermowell
Transmitter
Indicator etc.
Technical data

Weather Proof Head Type

Model No. | SS-5025W
(Sheath)

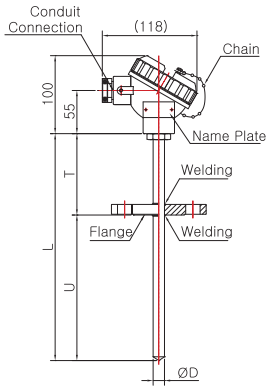

Model No. | SS-5025W-1
(Sheath)

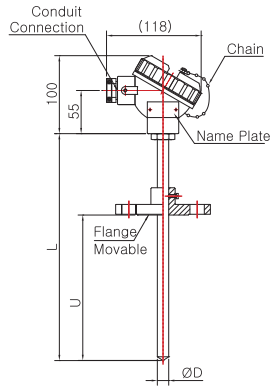

Model No. | SS-5026W-1
(Sheath)

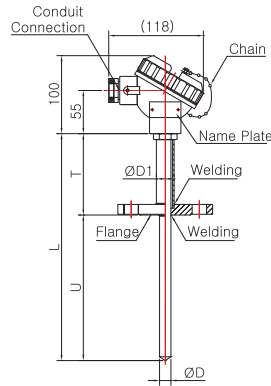

Model No. | SS-5026W-1-1
(Sheath Spring Load)

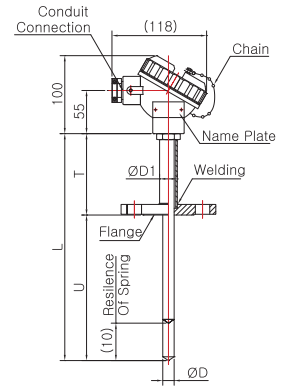

Model No. | SS-5026W-2
(Sheath)

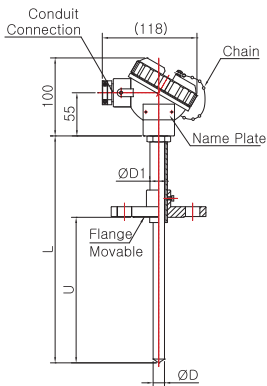

Model No. | SS-5026W-3
(Sheath)

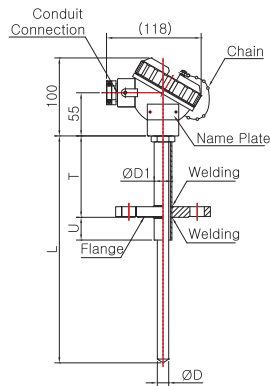

Model No. | SS-5029W
(Sheath)

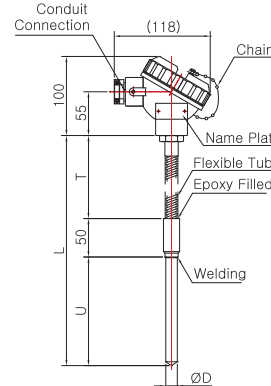

Model No. | SS-5029W-1
(Sheath)

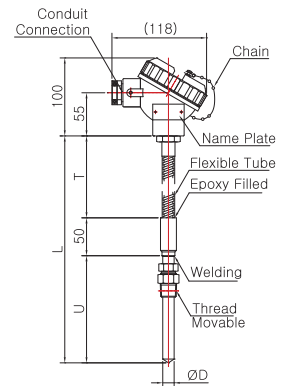

Model No. | SS-5029W-3
(Sheath)

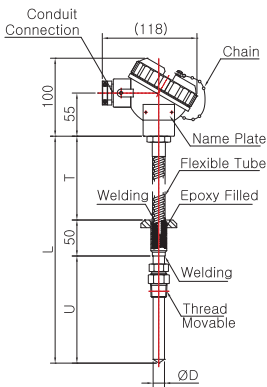

Pressure Gauge

Differential Pressure Gauge & Switch

Accessories of Pressure Gauge

Thermometer & Thermometer Switch

Thermocouple & R.T.D

Thermowell

Transmitter

Indicator etc.

Technical data

Sheath Thermocouple

Model No. SS-5020 Series

Explosion Proof Head Type (Ex d IIC T6)

Model No. | SS-5021E
(Sheath)

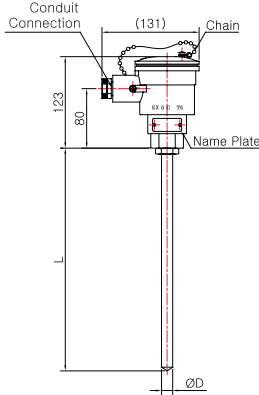

Model No. | SS-5022E
(Sheath)

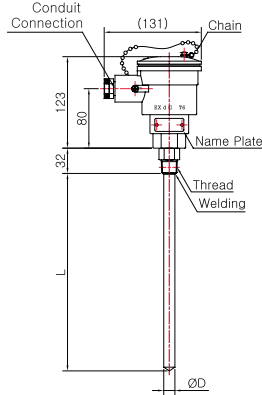

Model No. | SS-5022E-1
(Sheath)

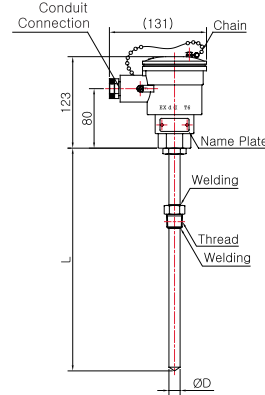

Model No. | SS-5022E-2
(Sheath)

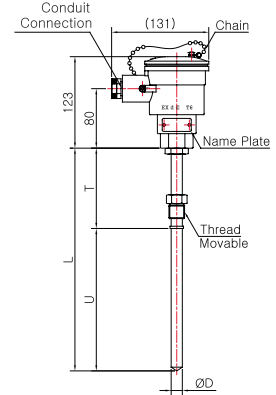

Model No. | SS-5022E-3
(Sheath)

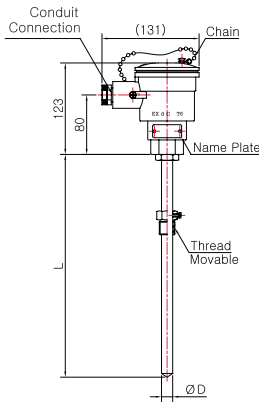

Model No. | SS-5022E-4
(Sheath)

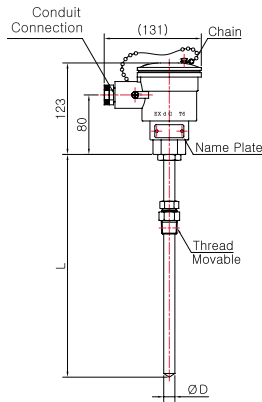

Model No. | SS-5023E
(Sheath)

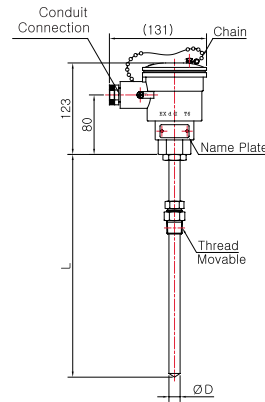

Model No. | SS-5023E-1
(Sheath)

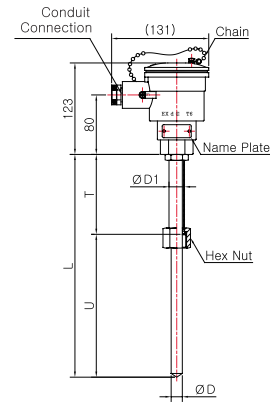

Model No. | SS-5024E-1
(Sheath)

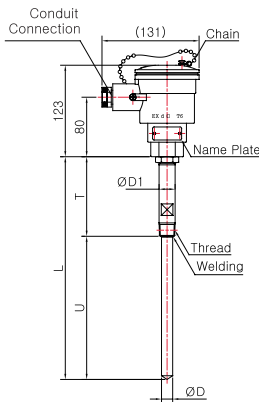

Model No. | SS-5024E-1-1
(Sheath Spring Load)

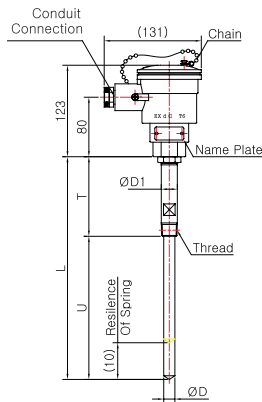

Model No. | SS-5024E-2
(Sheath)

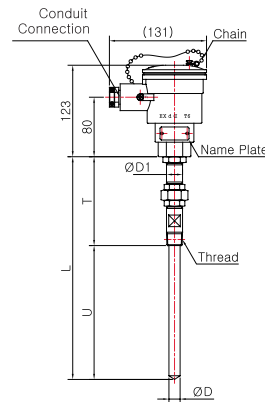

Model No. | SS-5024E-2-1
(Sheath Spring Load)

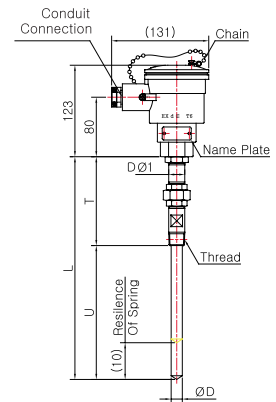

Pressure Gauge
Differential Pressure Gauge & Switch
Accessories of Pressure Gauge
Thermometer & Thermometer Switch
Thermocouple & R.T.D.
Thermowell
Transmitter
Indicator etc.
Technical data

Explosion Proof Head Type (Ex d IIC T6)

Model No. | SS-5025E
(Sheath)

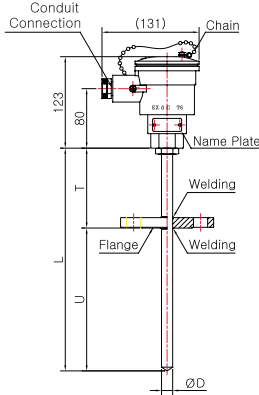

Model No. | SS-5025E-1
(Sheath)

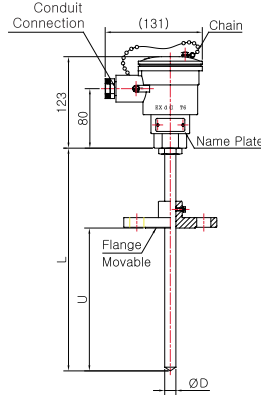

Model No. | SS-5026E-1
(Sheath)

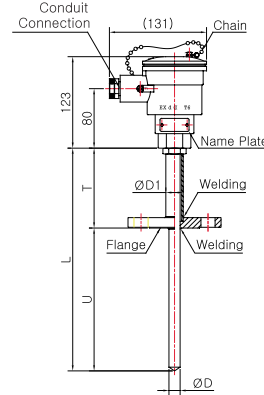

Model No. | SS-5026E-1-1
(Sheath Spring Load)

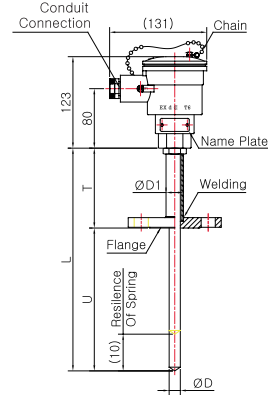

Model No. | SS-5026E-2
(Sheath)

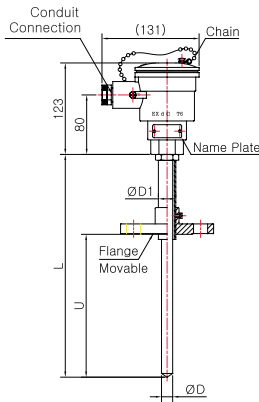

Model No. | SS-5026E-3
(Sheath)

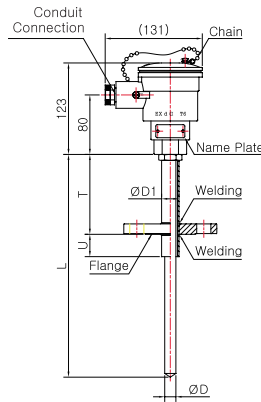

Model No. | SS-5029E
(Sheath)

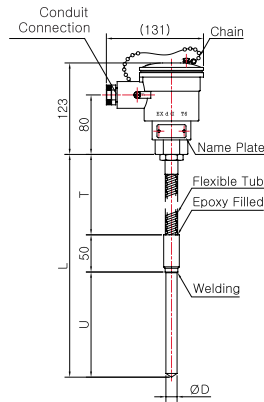

Model No. | SS-5029E-1
(Sheath)

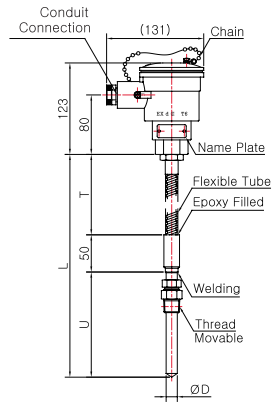

Model No. | SS-5029E-3
(Sheath)

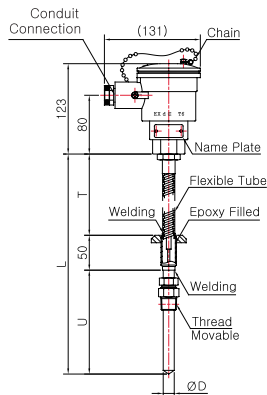

Pressure Gauge

Differential Pressure Gauge & Switch

Accessories of Pressure Gauge

Thermometer & Thermometer Switch

Thermocouple & R.T.D

Thermowell

Transmitter

Indicator etc.

Technical data

Sheath Thermocouple

Model No. SS-5020 Series

General Purpose Head Type

Model No. | SS-5021S
(Sheath)

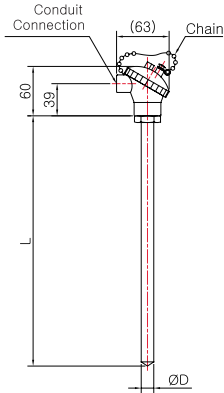

Model No. | SS-5022S
(Sheath)

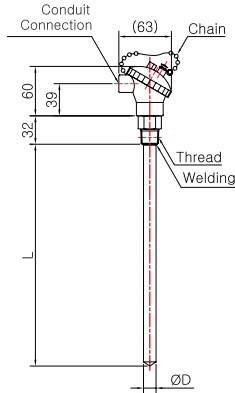

Model No. | SS-5022S-1
(Sheath)

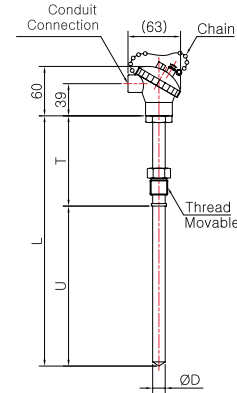

Model No. | SS-5022S-2
(Sheath)

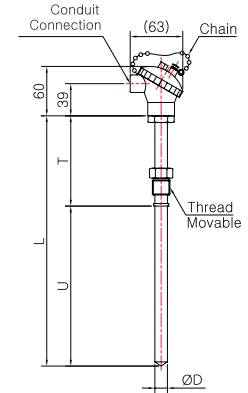

Model No. | SS-5022S-3
(Sheath)

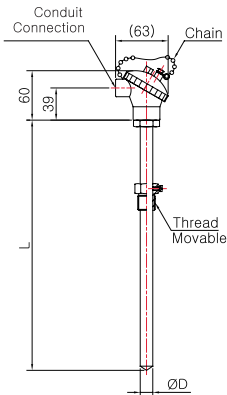

Model No. | SS-5022S-4
(Sheath)

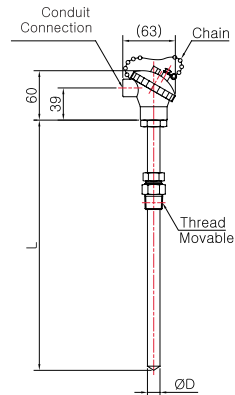

Model No. | SS-5023S
(Sheath)

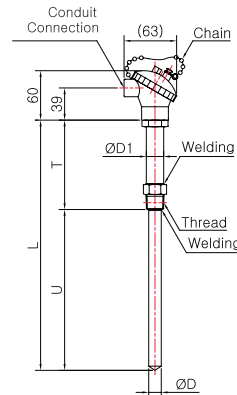

Model No. | SS-5023S-1
(Sheath)

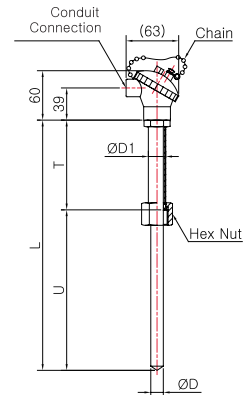

Model No. | SS-5024S-1
(Sheath)

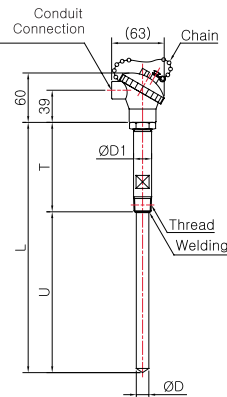

Model No. | SS-5024S-1-1
(Sheath Spring Load)

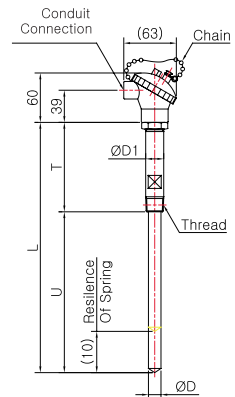

Model No. | SS-5024S-2
(Sheath)

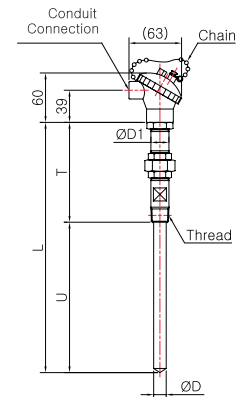

Model No. | SS-5024S-2-1
(Sheath Spring Load)

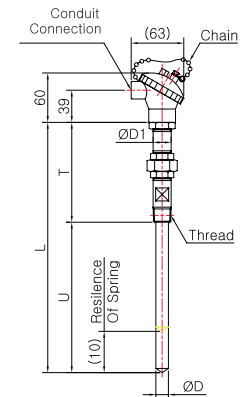

Pressure Gauge
Differential Pressure Gauge & Switch
Accessories of Pressure Gauge
Thermometer & Thermometer Switch
Thermocouple & R.T.D.
Thermowell
Transmitter
Indicator etc.
Technical data

General Purpose Head Type

Model No. | SS-5025S
(Sheath)

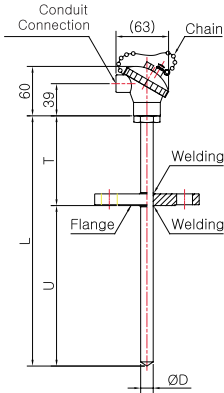

Model No. | SS-5025S-1
(Sheath)

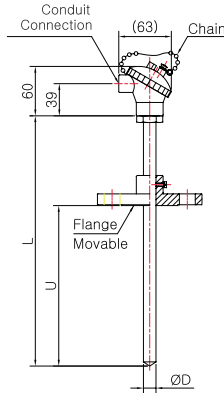

Model No. | SS-5026S-1
(Sheath)

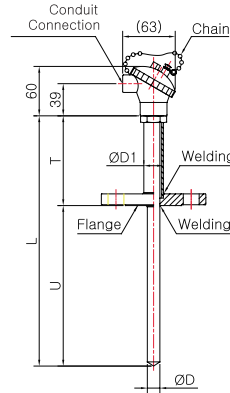

Model No. | SS-5026S-1-1
(Sheath Spring Load)

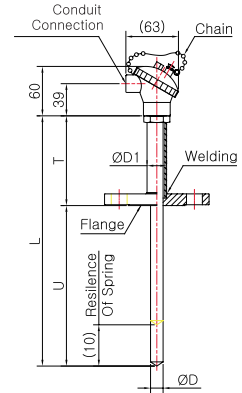

Model No. | SS-5026S-2
(Sheath)

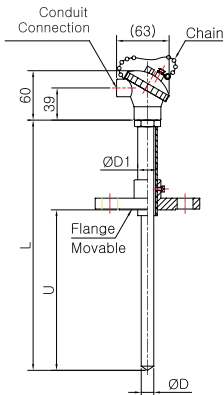

Model No. | SS-5026S-3
(Sheath)

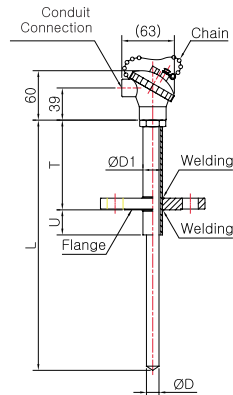

Model No. | SS-5029S
(Sheath)

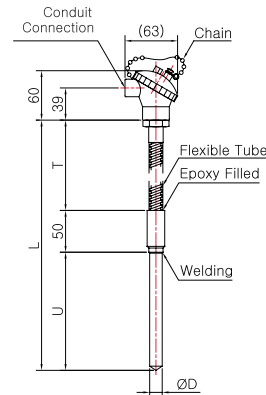

Model No. | SS-5029S-1
(Sheath)

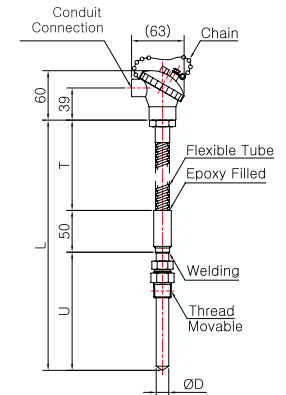

Model No. | SS-5029S-3
(Sheath)

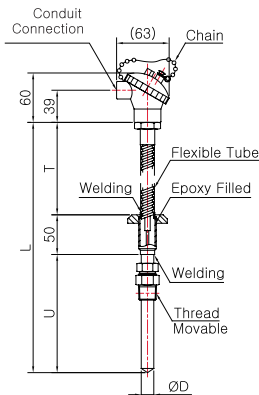

Pressure Gauge

Differential Pressure Gauge & Switch

Accessories of Pressure Gauge

Thermometer & Thermometer Switch

Thermocouple & R.T.D

Thermowell

Transmitter

Indicator etc.

Technical data

Sheath Thermocouple

Model No. SS-5020 Series

Extension Lead Wire Type

Model No. | SS-5028GA
(Basic)

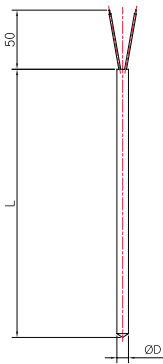

Model No. | SS-5028GB
(Compensating Lead Wire)

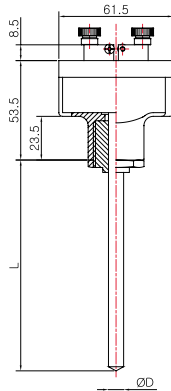

Model No. | SS-5028GC
(Compensating Lead Wire)

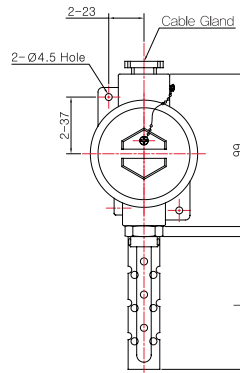

Model No. | SS-5028GD
(Sheath)

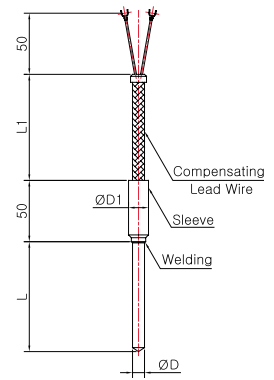

Model No. | SS-5028GD-1
(Compensating Lead Wire)

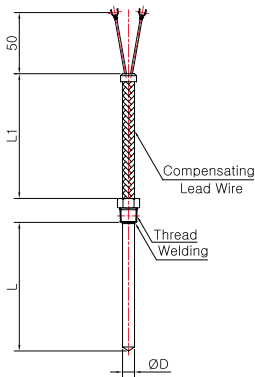

Model No. | SS-5028GD-2
(Sheath)

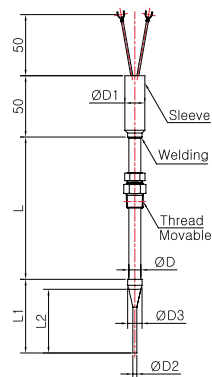

Model No. | SS-5028GDT
(Compensating Lead Wire)

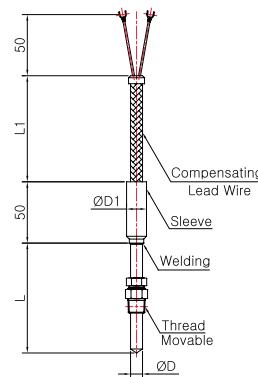

Model No. | SS-5028GE
(Flexible Tube)

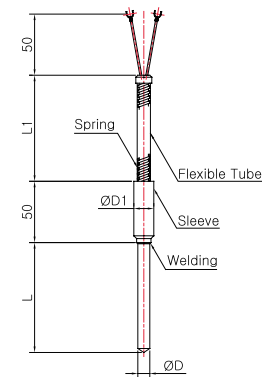

Model No. | SS-5028GET
(Flexible Tube)

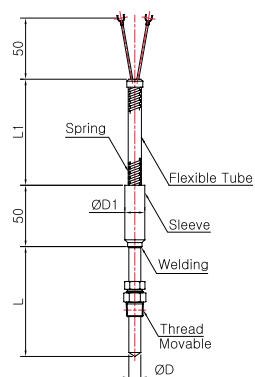

Model No. | SS-5028GF
(Bayonet Mount)

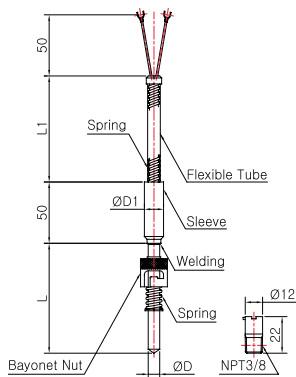

Model No. | SS-5028GG
(Quick Connector)

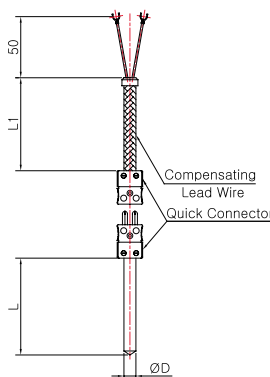

Model No. | SS-5028GH
(Metal Connector)

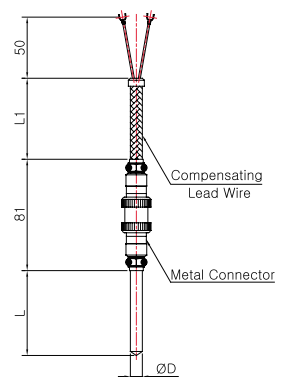

Pressure Gauge
Differential Pressure Gauge & Switch
Accessories of Pressure Gauge
Thermometer & Thermometer Switch
Thermocouple & R.T.D.
Thermowell
Transmitter
Indicator etc.
Technical data

Special Type

Model No. | SS-5029W-A

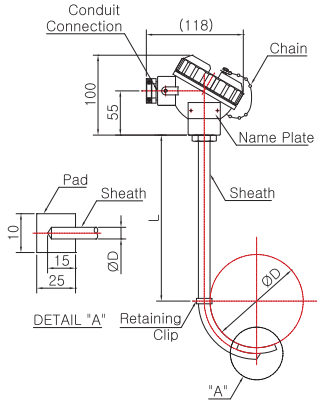

Model No. | SS-5029W-B

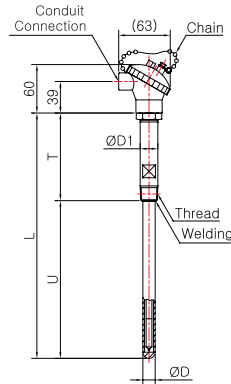

Model No. | SS-5029E-A

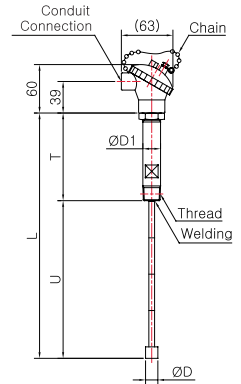

Model No. | SS-5029E-B

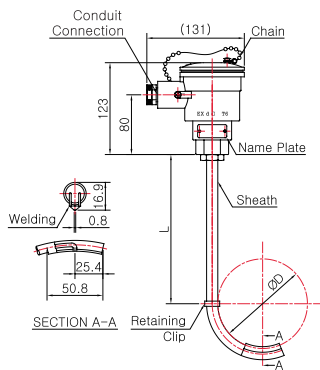

Model No. | SS-5028GDF

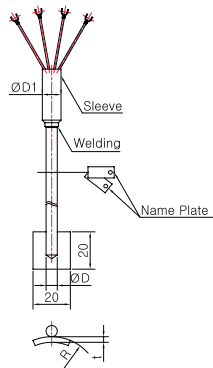

Model No. | MULTI

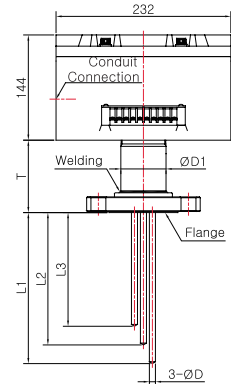

Pressure Gauge

Differential Pressure Gauge & Switch

Accessories of Pressure Gauge

Thermometer & Thermometer Switch

Thermocouple & R.T.D

Thermowell

Transmitter

Indicator etc.

Technical data

Resistance Temperature Detectors

Model No. SS-5030 Series

Weather Proof Head Type

Model No. | SS-5031W
(Metal Protection Tube)

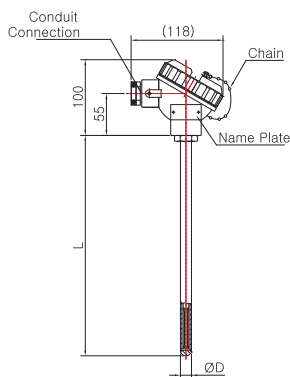

Model No. | SS-5031W-2
(Metal Protection Tube)

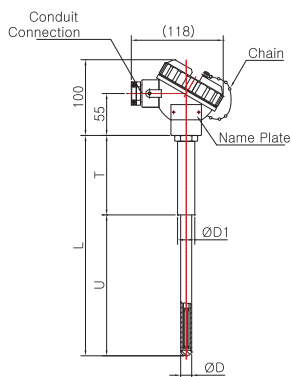

Model No. | SS-5032W
(Metal Protection Tube)

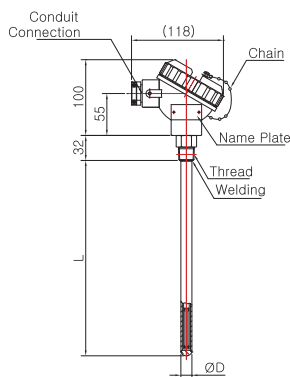

Model No. | SS-5032W-1
(Metal Protection Tube)

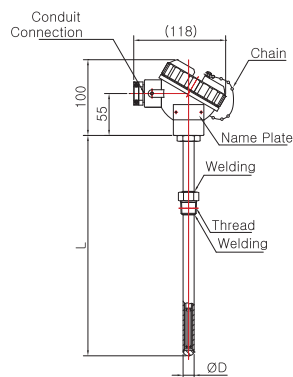

Model No. | SS-5032W-2
(Metal Protection Tube)

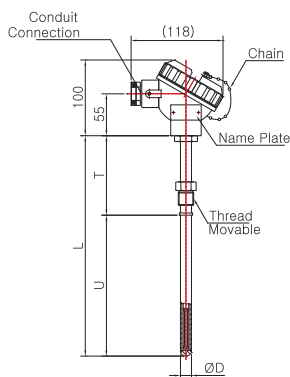

Model No. | SS-5032W-3
(Metal Protection Tube)

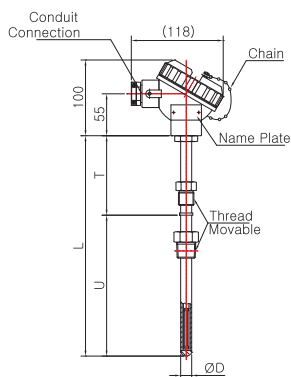

Model No. | SS-5032W-4
(Metal Protection Tube)

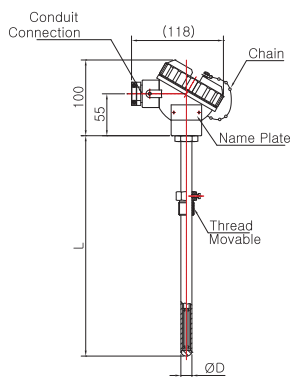

Model No. | SS-5032W-6
(Metal Protection Tube)

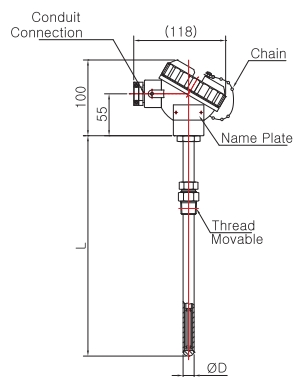

Model No. | SS-5033W
(Metal Protection Tube)

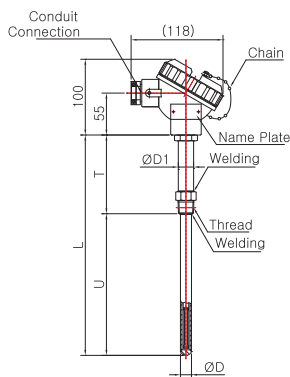

Model No. | SS-5034W-1
(Metal Protection Tube)

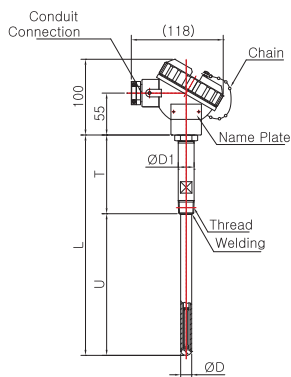

Model No. | SS-5034W-2
(Metal Protection Tube)

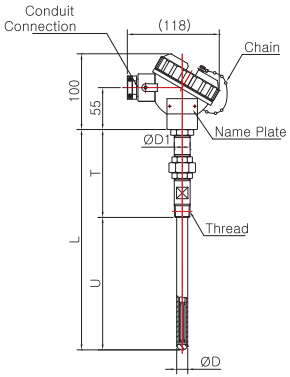

Model No. | SS-5035W
(Metal Protection Tube)

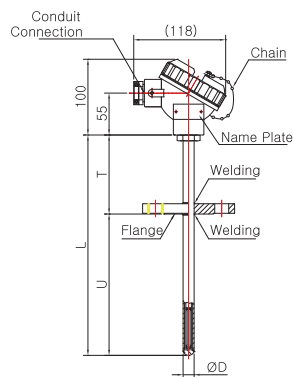

Pressure Gauge
Differential Pressure Gauge & Switch
Accessories of Pressure Gauge
Thermometer & Thermometer Switch
Thermocouple & R.T.D.
Thermowell
Transmitter
Indicator etc.
Technical data

Weather Proof Head Type

Model No. | SS-5035W-1
(Metal Protection Tube)

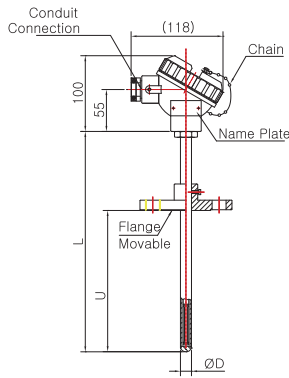

Model No. | SS-5036W
(Metal Protection Tube)

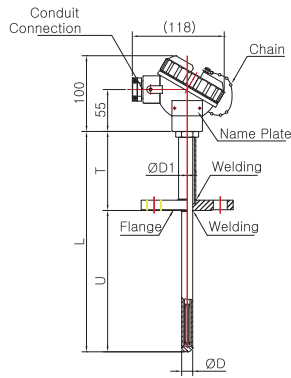

Model No. | SS-5036W-2
(Metal Protection Tube)

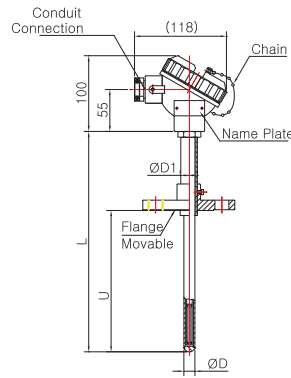

Model No. | SS-5036W-3
(Metal Protection Tube)

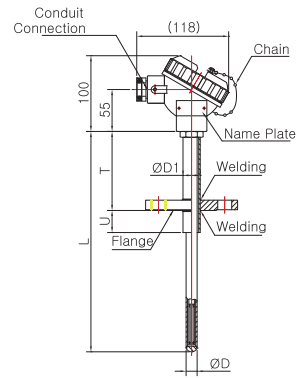

Model No. | SS-5037W
(Metal Protection Tube)

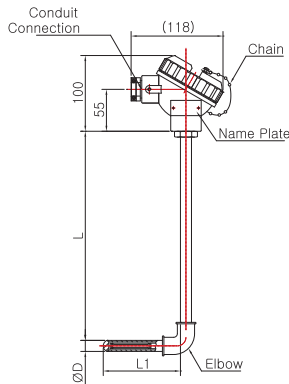

Model No. | SS-5039W
(Metal Protection Tube)

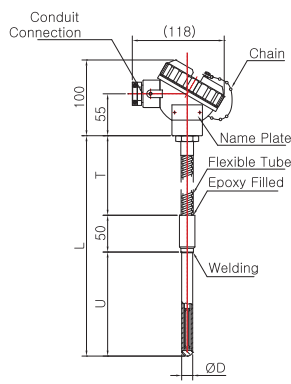

Model No. | SS-5039W-1
(Metal Protection Tube)

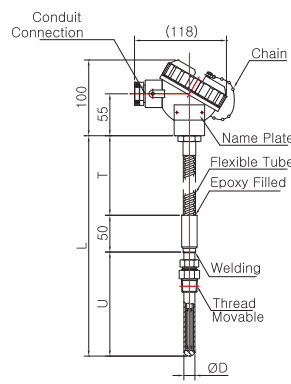

Model No. | SS-5039W-2
(Metal Protection Tube)

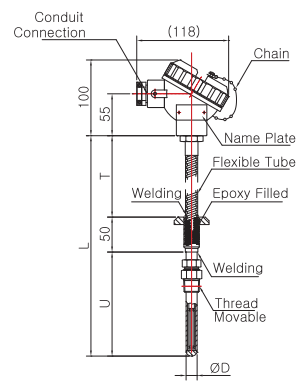

Pressure Gauge

Differential Pressure Gauge & Switch

Accessories of Pressure Gauge

Thermometer & Thermometer Switch

Thermocouple & R.T.D

Thermowell

Transmitter

Indicator etc.

Technical data

Resistance Temperature Detectors

Model No. SS-5030 Series

Explosion Proof Head Type (Ex d IIC T6)

Model No. | SS-5031E
(Metal Protection Tube)

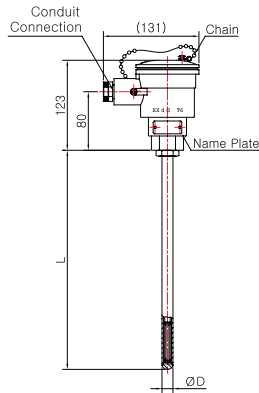

Model No. | SS-5031E-2
(Metal Protection Tube)

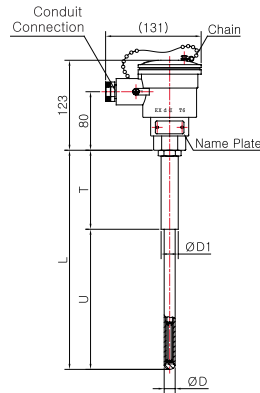

Model No. | SS-5032E
(Metal Protection Tube)

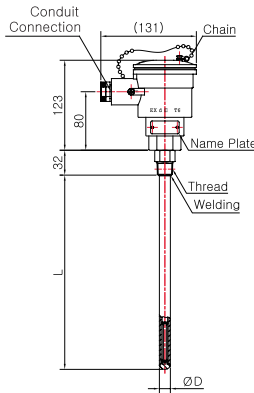

Model No. | SS-5032E-1
(Metal Protection Tube)

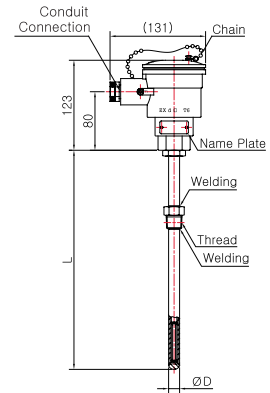

Model No. | SS-5032E-2
(Metal Protection Tube)

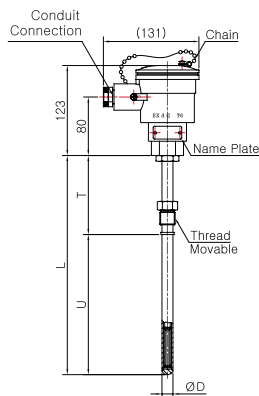

Model No. | SS-5032E-3
(Metal Protection Tube)

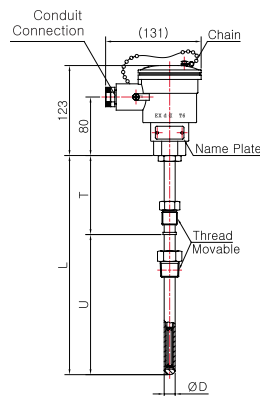

Model No. | SS-5032E-4
(Metal Protection Tube)

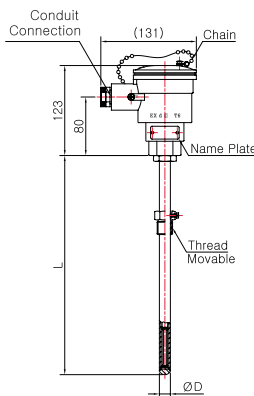

Model No. | SS-5032E-6
(Metal Protection Tube)

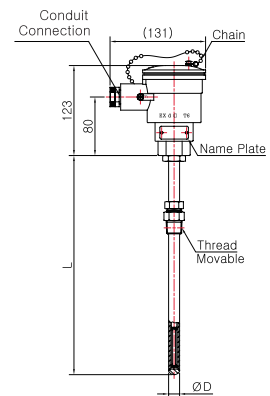

Model No. | SS-5033E
(Metal Protection Tube)

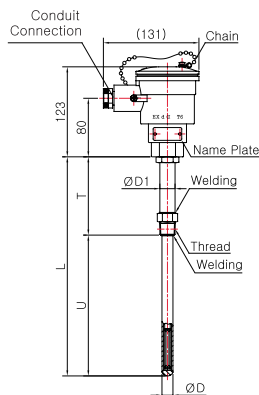

Model No. | SS-5034E-1
(Metal Protection Tube)

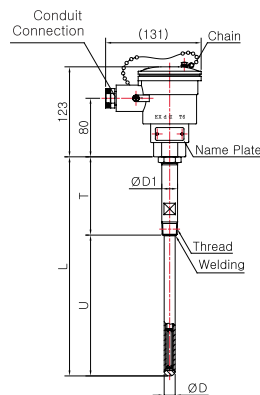

Model No. | SS-5034E-2
(Metal Protection Tube)

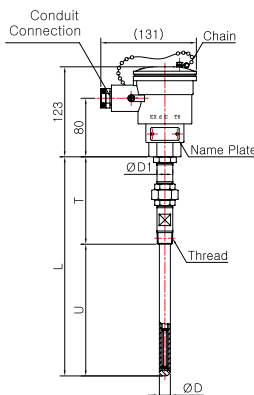

Model No. | SS-5035E
(Metal Protection Tube)

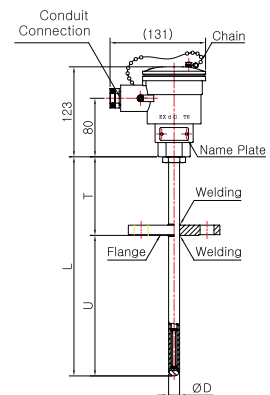

Pressure Gauge
Differential Pressure Gauge & Switch
Accessories of Pressure Gauge
Thermometer & Thermometer Switch
Thermocouple & R.T.D.
Thermowell
Transmitter
Indicator etc.
Technical data

Explosion Proof Head Type (Ex d IIC T6)

Model No. | SS-5035E-1
(Metal Protection Tube)

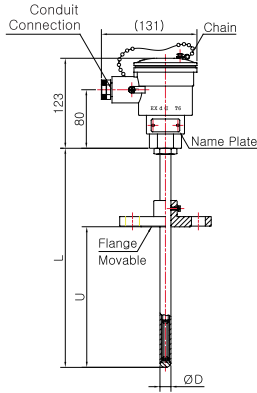

Model No. | SS-5036E
(Metal Protection Tube)

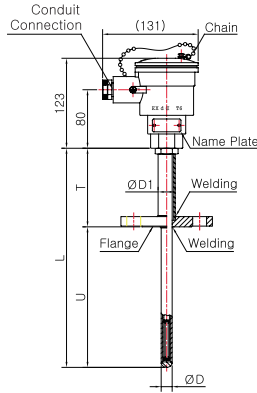

Model No. | SS-5036E-2
(Metal Protection Tube)

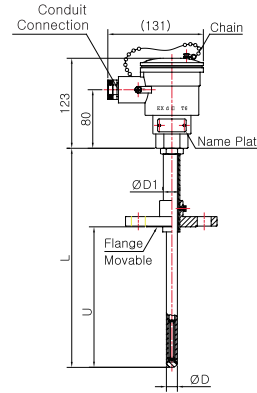

Model No. | SS-5036E-3
(Metal Protection Tube)

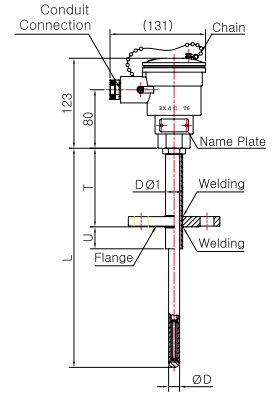

Model No. | SS-5037E
(Metal Protection Tube)

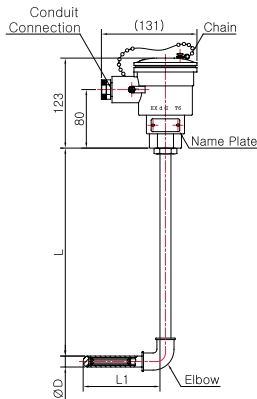

Model No. | SS-5039E
(Metal Protection Tube)

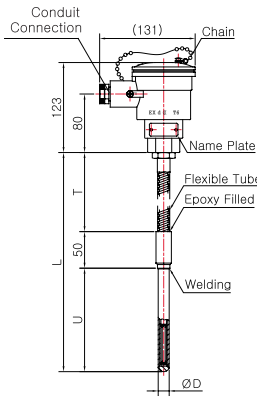

Model No. | SS-5039E-1
(Metal Protection Tube)

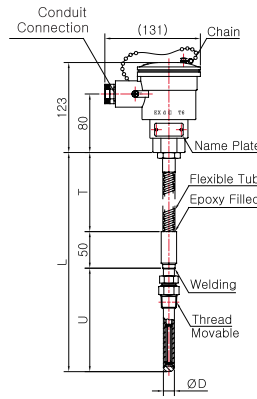

Model No. | SS-5039E-2
(Metal Protection Tube)

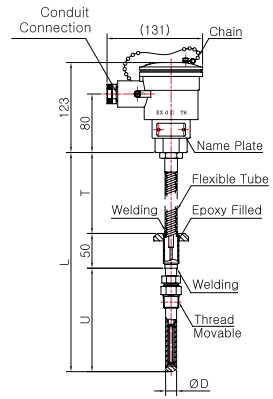

Pressure Gauge

Differential Pressure Gauge & Switch

Accessories of Pressure Gauge

Thermometer & Thermometer Switch

Thermocouple & R.T.D

Thermowell

Transmitter

Indicator etc.

Technical data

Resistance Temperature Detectors

Model No. SS-5030 Series

General Purpose Head Type

Model No. | SS-5031S
(Metal Protection Tube)

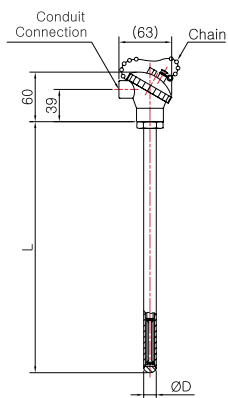

Model No. | SS-5031S-2
(Metal Protection Tube)

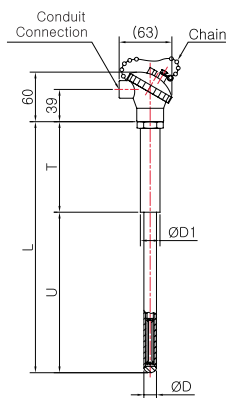

Model No. | SS-5032S
(Metal Protection Tube)

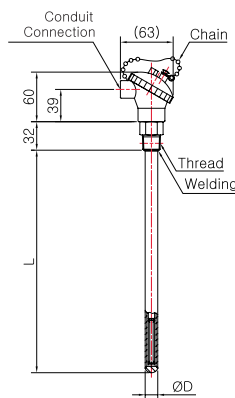

Model No. | SS-5032S-1
(Metal Protection Tube)

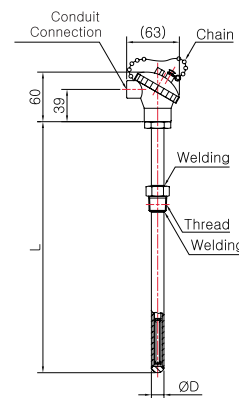

Model No. | SS-5032S-2
(Metal Protection Tube)

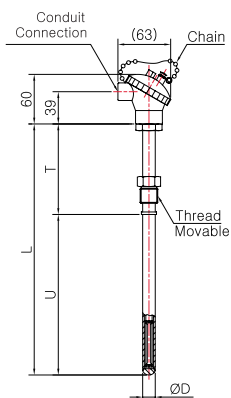

Model No. | SS-5032S-3
(Metal Protection Tube)

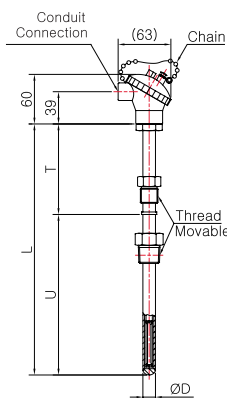

Model No. | SS-5032S-4
(Metal Protection Tube)

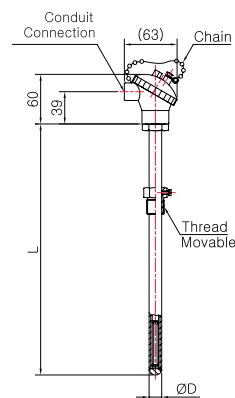

Model No. | SS-5032S-6
(Metal Protection Tube)

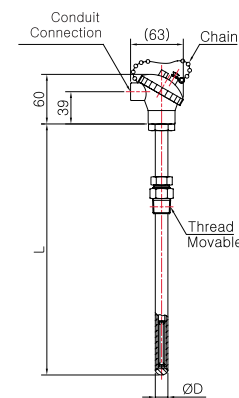

Model No. | SS-5033S
(Metal Protection Tube)

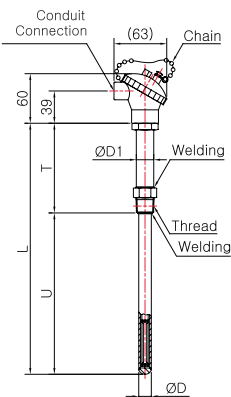

Model No. | SS-5034S-1
(Metal Protection Tube)

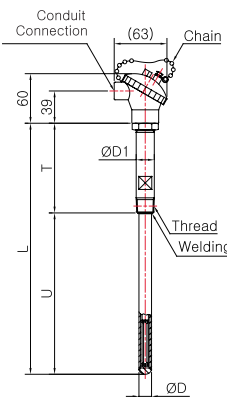

Model No. | SS-5034S-2
(Metal Protection Tube)

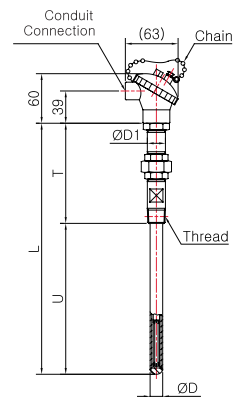

Model No. | SS-5035S
(Metal Protection Tube)

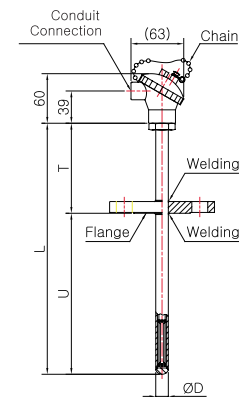

Pressure Gauge
Differential Pressure Gauge & Switch
Accessories of Pressure Gauge
Thermometer & Thermometer Switch
Thermocouple & R.T.D.
Thermowell
Transmitter
Indicator etc.
Technical data

General Purpose Head Type

Model No. | SS-5035S-1
(Metal Protection Tube)

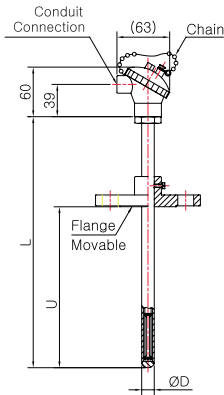

Model No. | SS-5036S
(Metal Protection Tube)

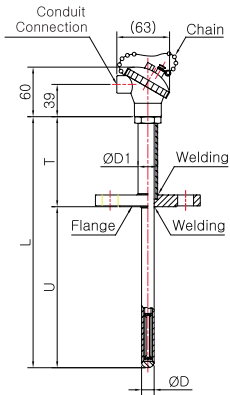

Model No. | SS-5036S-2
(Metal Protection Tube)

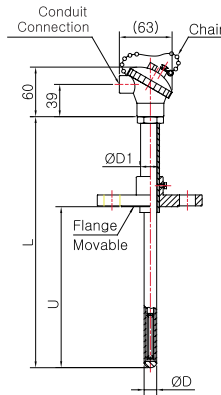

Model No. | SS-5036S-3
(Metal Protection Tube)

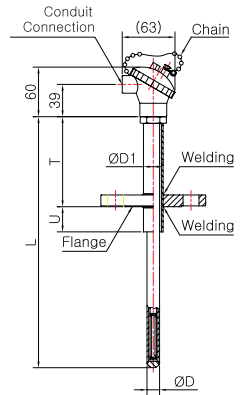

Model No. | SS-5037S
(Metal Protection Tube)

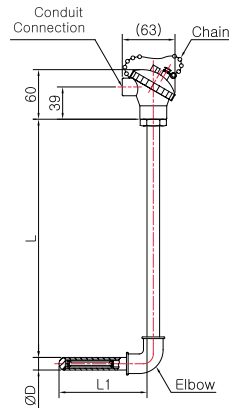

Model No. | SS-5039S
(Metal Protection Tube)

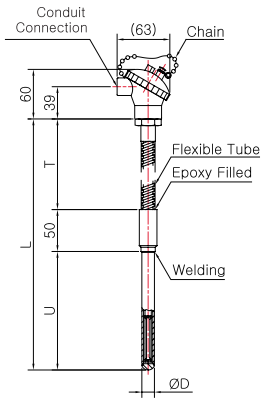

Model No. | SS-5039S-1
(Metal Protection Tube)

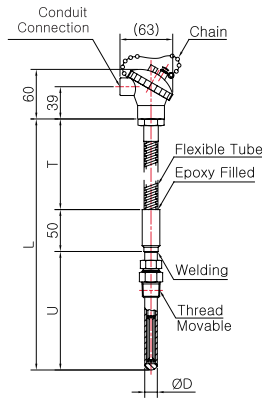

Model No. | SS-5039S-2
(Metal Protection Tube)

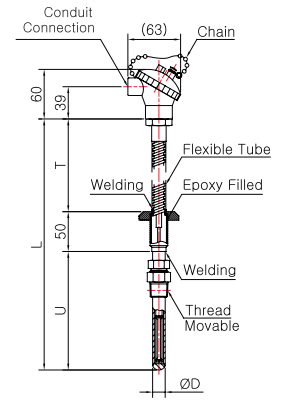

Pressure Gauge

Differential Pressure Gauge & Switch

Accessories of Pressure Gauge

Thermometer & Thermometer Switch

Thermocouple & R.T.D

Thermowell

Transmitter

Indicator etc.

Technical data

Sheath Resistance Temperature Detectors

Model No. SS-5040 Series

Weather Proof Head Type

Model No. | SS-5041W
(Sheath)

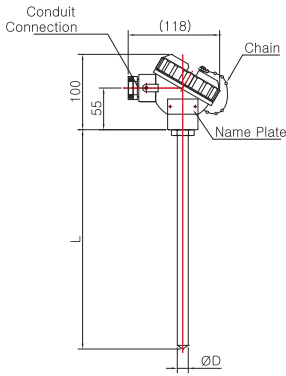

Model No. | SS-5042W
(Sheath)

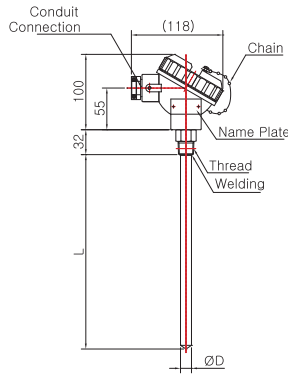

Model No. | SS-5042W-1
(Sheath)

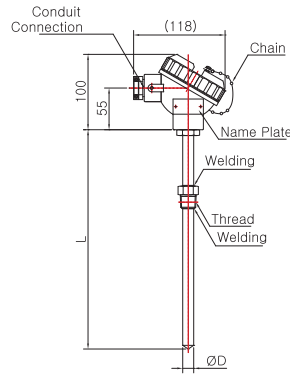

Model No. | SS-5042W-2
(Sheath)

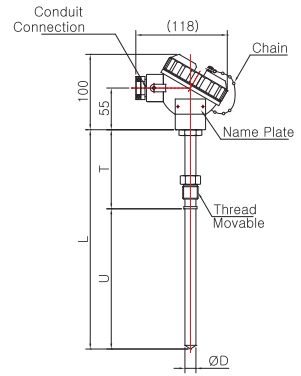

Model No. | SS-5042W-3
(Sheath)

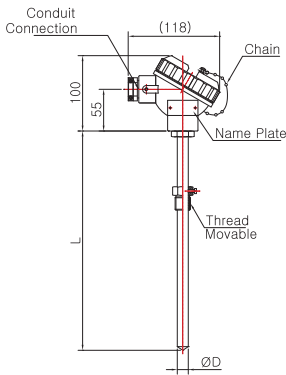

Model No. | SS-5042W-4
(Sheath)

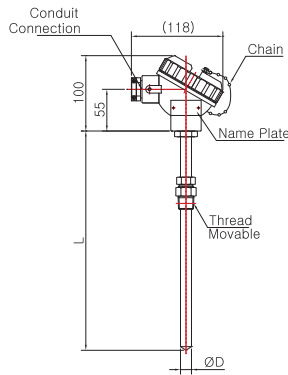

Model No. | SS-5043W
(Sheath)

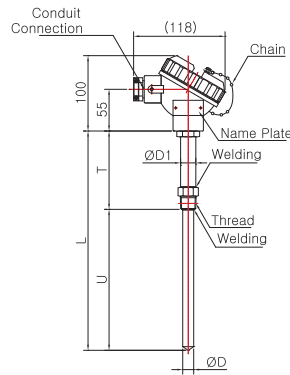

Model No. | SS-5043W-1
(Sheath)

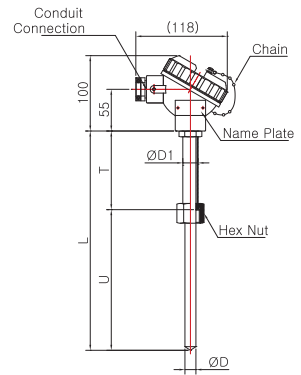

Model No. | SS-5044W-1
(Sheath)

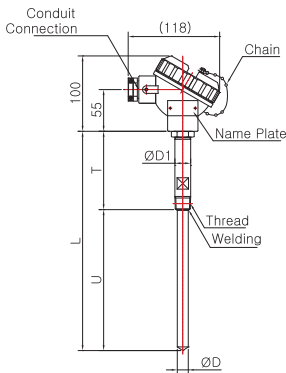

Model No. | SS-5044W-1-1
(Sheath Spring Load)

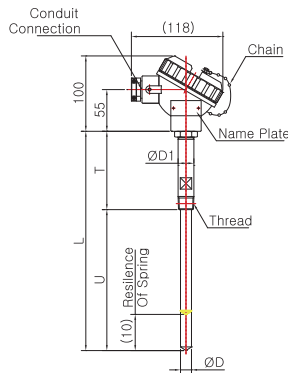

Model No. | SS-5044W-2
(Sheath)

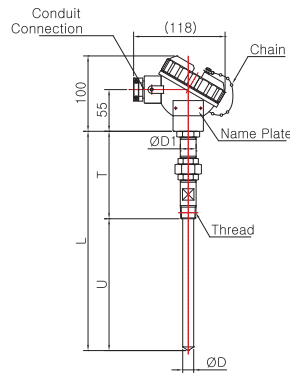

Model No. | SS-5044W-2-1
(Sheath Spring Load)

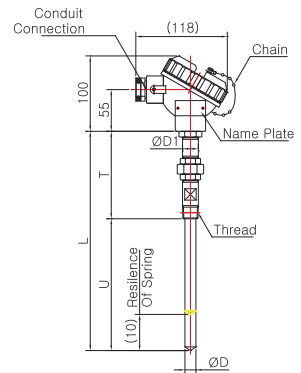

Pressure Gauge
Differential Pressure Gauge & Switch
Accessories of Pressure Gauge
Thermometer & Thermometer Switch
Thermocouple & R.T.D.
Thermowell
Transmitter
Indicator etc.
Technical data

Weather Proof Head Type

Model No. | SS-5045W
(Sheath)

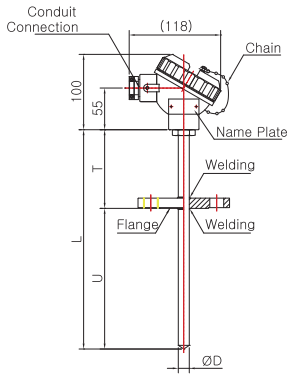

Model No. | SS-5045W-1
(Sheath)

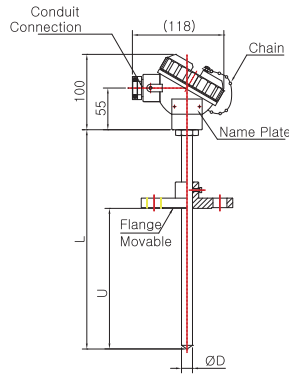

Model No. | SS-5046W-1
(Sheath)

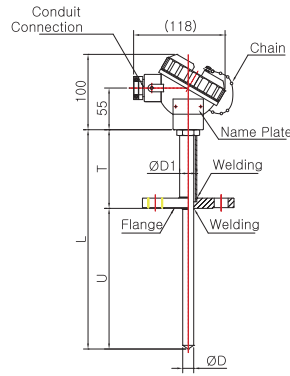

Model No. | SS-5046W-1-1
(Sheath Spring Load)

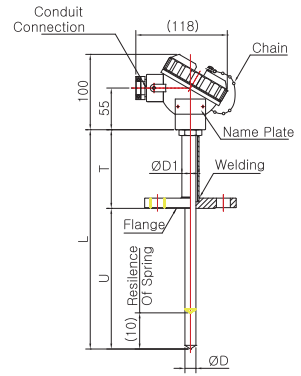

Model No. | SS-5046W-2
(Sheath)

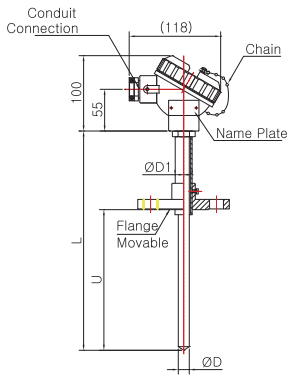

Model No. | SS-5046W-3
(Sheath)

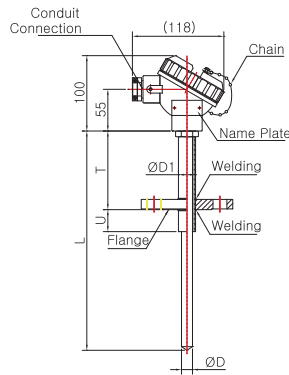

Model No. | SS-5049W
(Sheath)

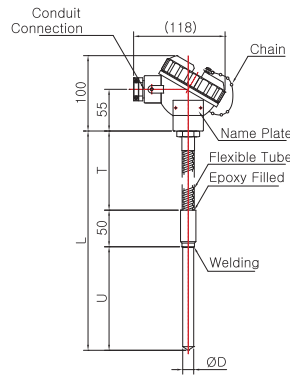

Model No. | SS-5049W-1
(Sheath)

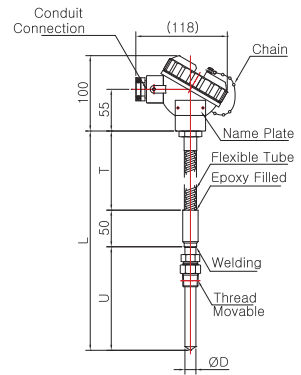

Model No. | SS-5049W-3
(Sheath)

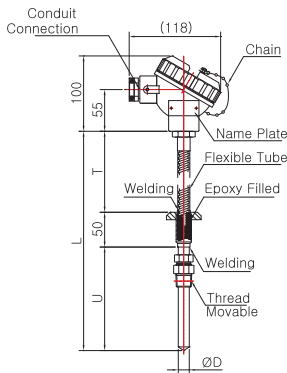

Pressure Gauge

Differential Pressure Gauge & Switch

Accessories of Pressure Gauge

Thermometer & Thermometer Switch

Thermocouple & R.T.D

Thermowell

Transmitter

Indicator etc.

Technical data

Sheath Resistance Temperature Detectors

Model No. SS-5040 Series

Explosion Proof Head Type (Ex d IIC T6)

Model No. | SS-5041E
(Sheath)

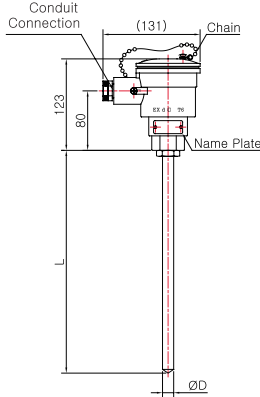

Model No. | SS-5042E
(Sheath)

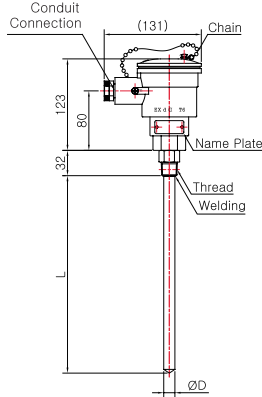

Model No. | SS-5042E-1
(Sheath)

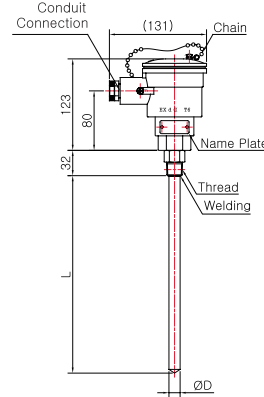

Model No. | SS-5042E-2
(Sheath)

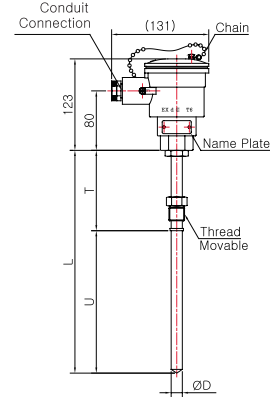

Model No. | SS-5042E-3
(Sheath)

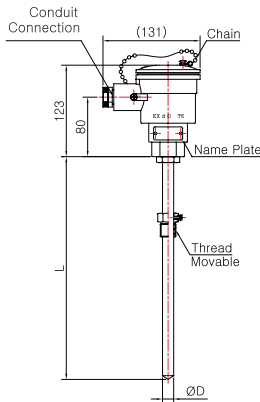

Model No. | SS-5042E-4
(Sheath)

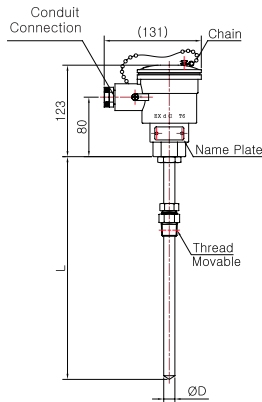

Model No. | SS-5043E
(Sheath)

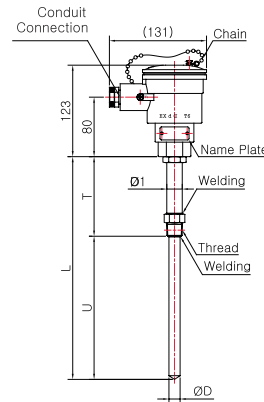

Model No. | SS-5043E-1
(Sheath)

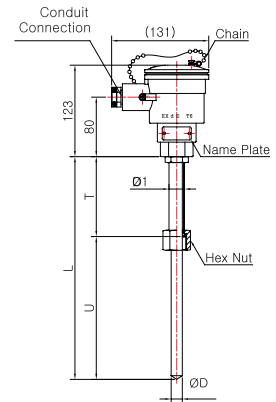

Model No. | SS-5044E-1
(Sheath)

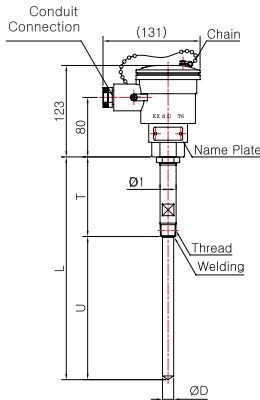

Model No. | SS-5044E-1-1
(Sheath Spring Load)

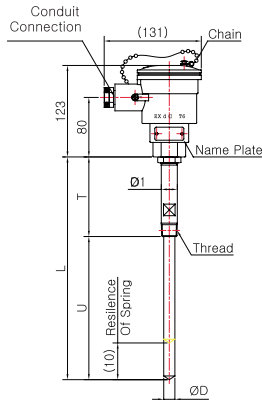

Model No. | SS-5044E-2
(Sheath)

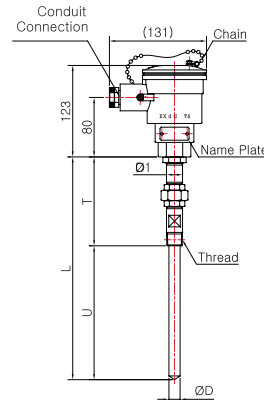

Model No. | SS-5044E-2-1
(Sheath Spring Load)

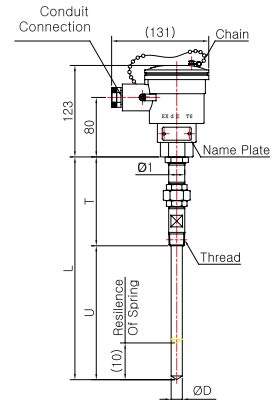

Pressure Gauge
Differential Pressure Gauge & Switch
Accessories of Pressure Gauge
Thermometer & Thermometer Switch
Thermocouple & R.T.D.
Thermowell
Transmitter
Indicator etc.
Technical data

Explosion Proof Head Type (Ex d IIC T6)

Model No. | SS-5045E
(Sheath)

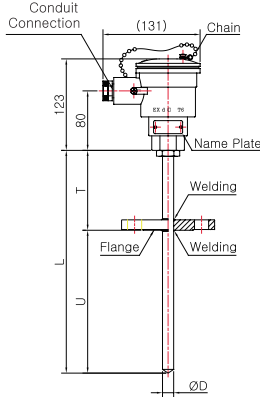

Model No. | SS-5045E-1
(Sheath)

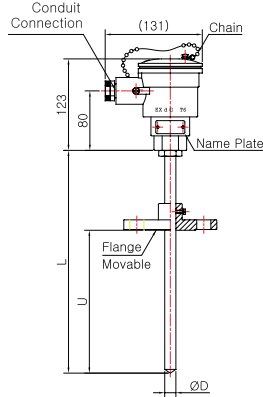

Model No. | SS-5046E-1
(Sheath)

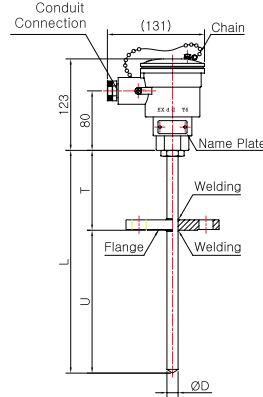

Model No. | SS-5046E-1-1
(Sheath Spring Load)

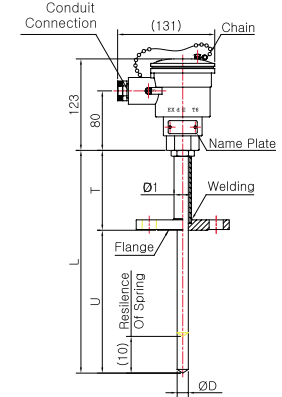

Model No. | SS-5046E-2
(Sheath)

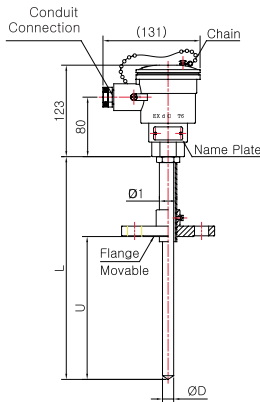

Model No. | SS-5046E-3
(Sheath)

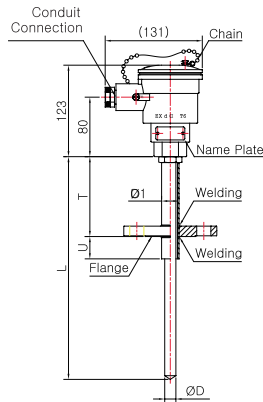

Model No. | SS-5049E
(Sheath)

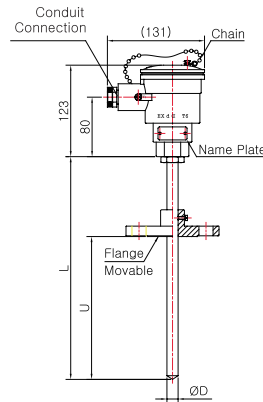

Model No. | SS-5049E-1
(Sheath)

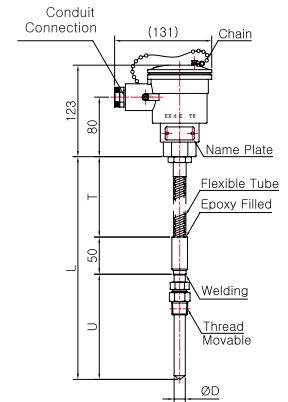

Model No. | SS-5049E-3
(Sheath)

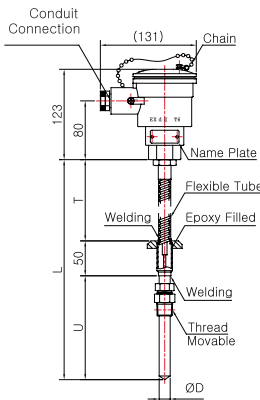

Pressure Gauge

Differential Pressure Gauge & Switch

Accessories of Pressure Gauge

Thermometer & Thermometer Switch

Thermocouple & R.T.D

Thermowell

Transmitter

Indicator etc.

Technical data

Sheath Resistance Temperature Detectors

Model No. SS-5040 Series

General Purpose Head Type

Model No. | SS-5041S
(Sheath)

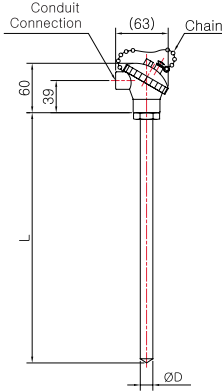

Model No. | SS-5042S
(Sheath)

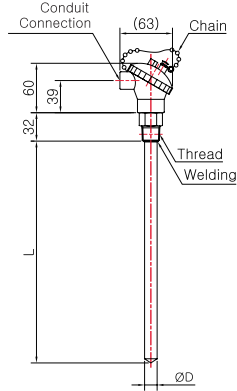

Model No. | SS-5042S-1
(Sheath)

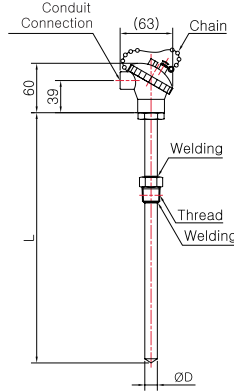

Model No. | SS-5042S-2
(Sheath)

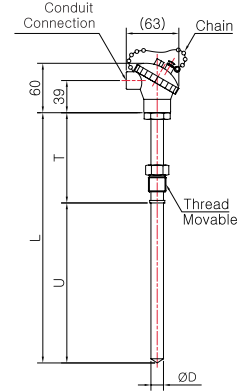

Model No. | SS-5042S-3
(Sheath)

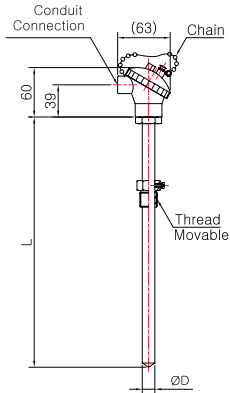

Model No. | SS-5042S-4
(Sheath)

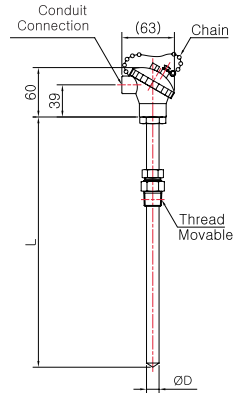

Model No. | SS-5043S
(Sheath)

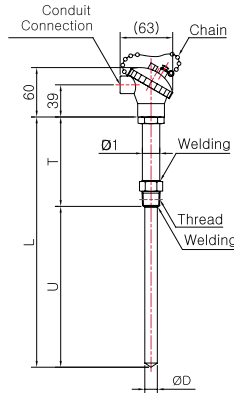

Model No. | SS-5043S-1
(Sheath)

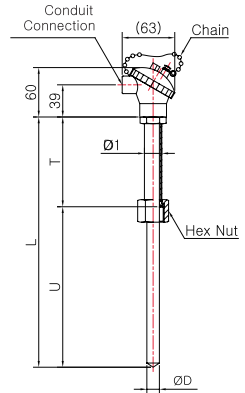

Model No. | SS-5044S-1
(Sheath)

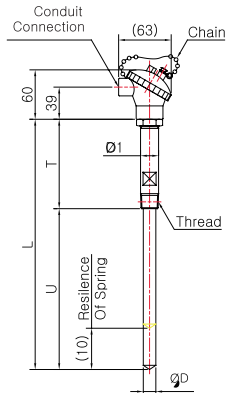

Model No. | SS-5044S-1-1
(Sheath Spring Load)

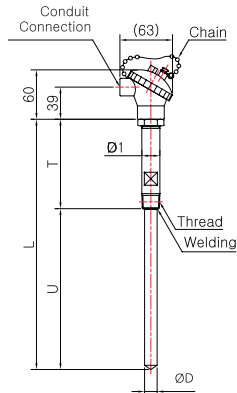

Model No. | SS-5044S-2
(Sheath)

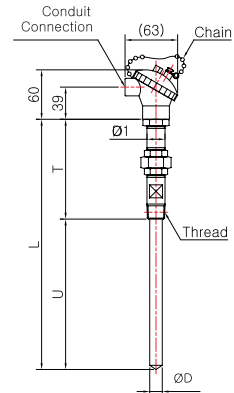

Model No. | SS-5044S-2-1
(Sheath Spring Load)

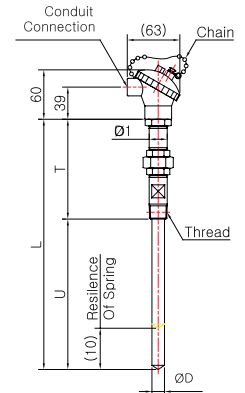

Pressure Gauge
Differential Pressure Gauge & Switch
Accessories of Pressure Gauge
Thermometer & Thermometer Switch
Thermocouple & R.T.D.
Thermowell
Transmitter
Indicator etc.
Technical data

General Purpose Head Type

Model No. | SS-5045S
(Sheath)

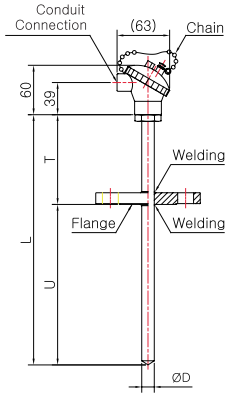

Model No. | SS-5045S-1
(Sheath)

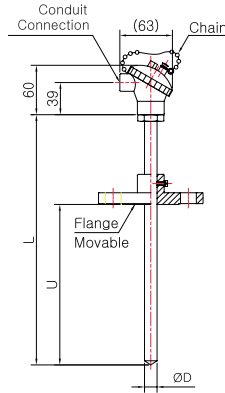

Model No. | SS-5046S-1
(Sheath)

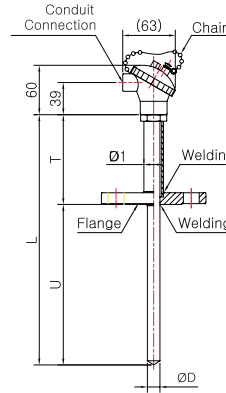

Model No. | SS-5046S-1-1
(Sheath Spring Load)

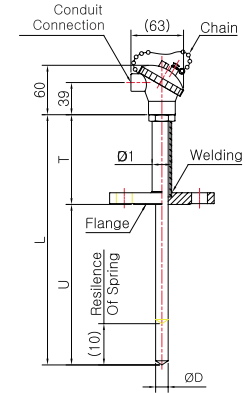

Model No. | SS-5046S-2
(Sheath)

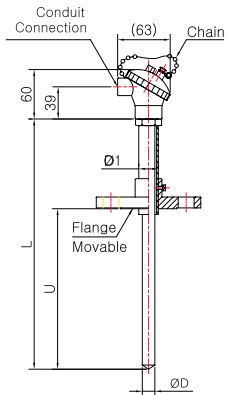

Model No. | SS-5046S-3
(Sheath)

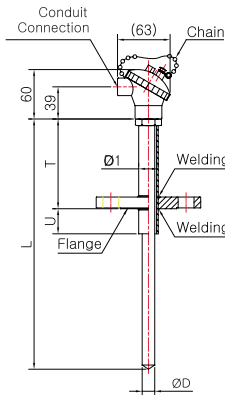

Model No. | SS-5049S
(Sheath)

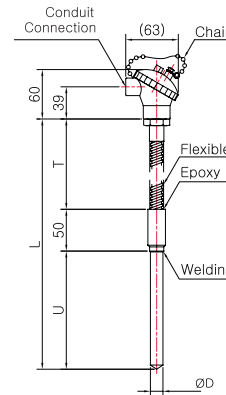

Model No. | SS-5049S-1
(Sheath)

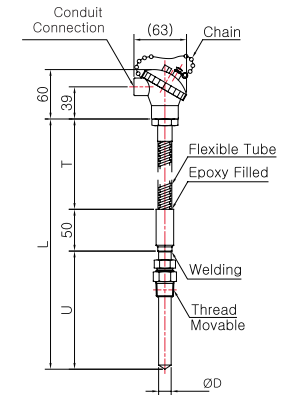

Model No. | SS-5049S-3
(Sheath)

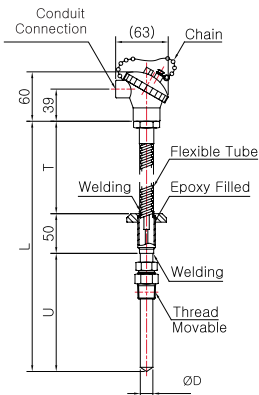

Pressure Gauge

Differential Pressure Gauge & Switch

Accessories of Pressure Gauge

Thermometer & Thermometer Switch

Thermocouple & R.T.D

Thermowell

Transmitter

Indicator etc.

Technical data

Sheath Resistance Temperature Detectors

Model No. SS-5040 Series

Extension Lead Wire Type

Model No. | SS-5048GA
(Basic)

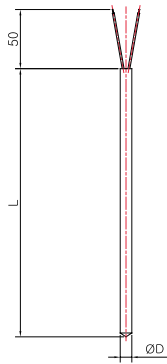

Model No. | SS-5048GB
(Compensating Lead Wire)

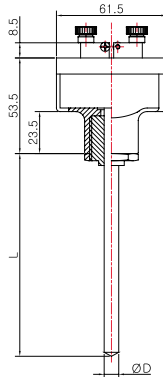

Model No. | SS-5048GC
(Compensating Lead Wire)

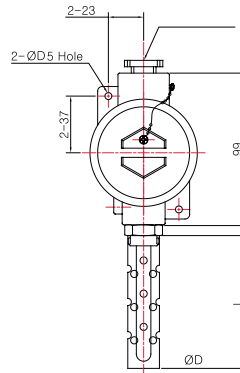

Model No. | SS-5048GD
(Sheath)

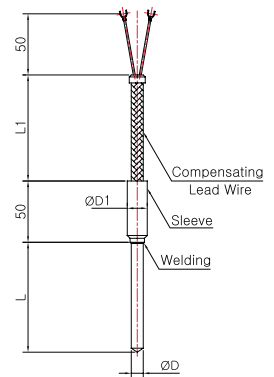

Model No. | SS-5048GD-1
(Compensating Lead Wire)

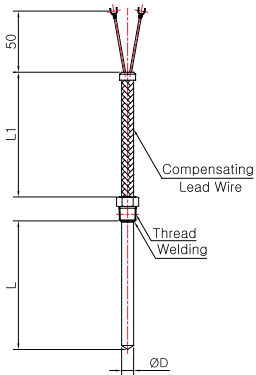

Model No. | SS-5048GD-2
(Sheath)

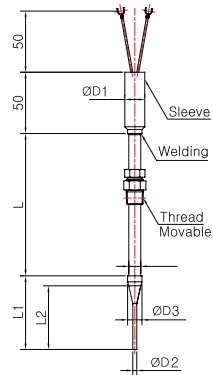

Model No. | SS-5048GDT
(Compensating Lead Wire)

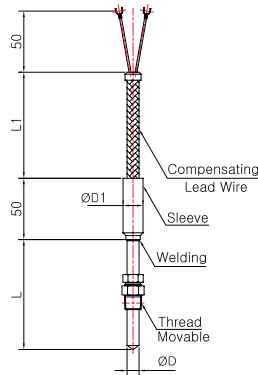

Model No. | SS-5048GE
(Flexible Tube)

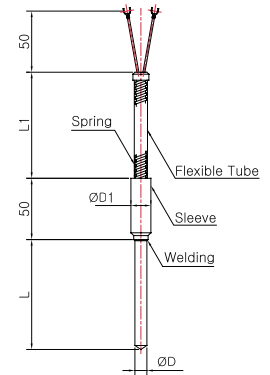

Model No. | SS-5048GET
(Flexible Tube)

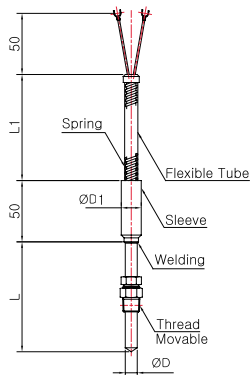

Model No. | SS-5048GF
(Bayonet Mount)

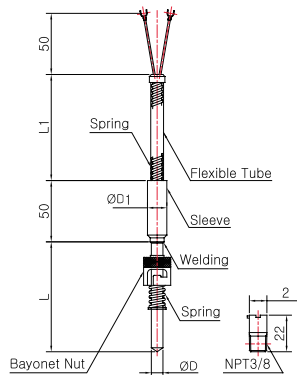

Model No. | SS-5048GG
(Quick Connector)

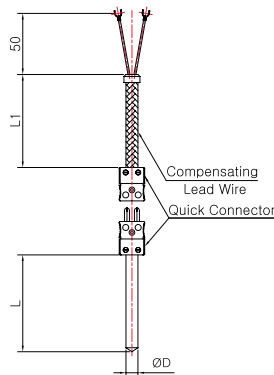

Model No. | SS-5048GH
(Metal Connector)

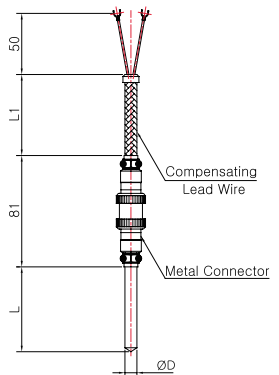

Pressure Gauge
Differential Pressure Gauge & Switch
Accessories of Pressure Gauge
Thermometer & Thermometer Switch
Thermocouple & R.T.D.
Thermowell
Transmitter
Indicator etc.
Technical data

Special Type

Model No. | SS-5049W-A

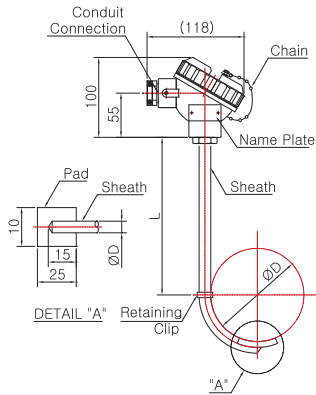

Model No. | SS-5049W-B
(Metal Protection Tube)

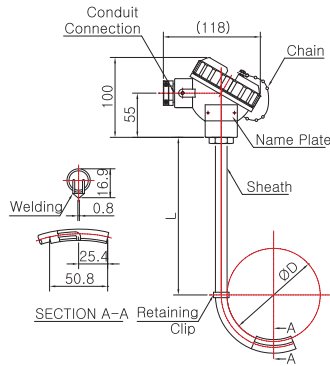

Model No. | SS-5049W-A
(Metal Protection Tube)

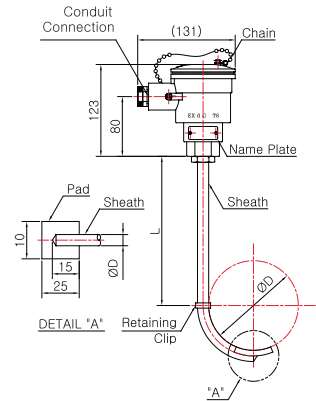

Model No. | SS-5029E-B

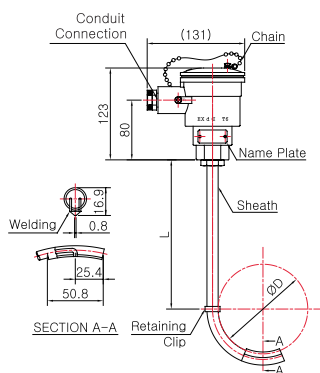

Model No. | SS-5029GDF

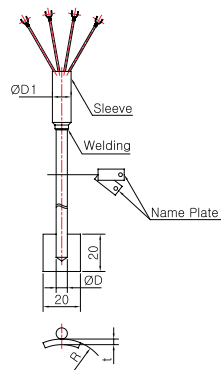

Model No. | MULTI

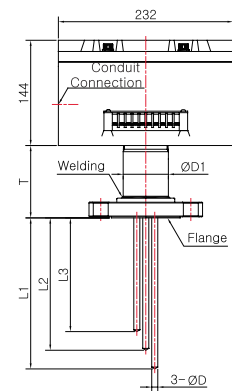

Pressure Gauge

Differential Pressure Gauge & Switch

Accessories of Pressure Gauge

Thermometer & Thermometer Switch

Thermocouple & R.T.D

Thermowell

Transmitter

Indicator etc.

Technical data